User's Guide

Publication Number 54622-97036
September 2002

For Safety Information and Regulatory information,
see the pages behind the Index.

© Copyright Agilent Technologies 2000-2002
All Rights Reserved



Agilent 54621A/22A/24A/41A/42A Oscilloscopes and Agilent 54621D/22D/41D/42D Mixed-Signal Oscilloscopes

The Oscilloscopes at a Glance

Choose from a variety of oscilloscopes for capturing long, non-repeating signals

with 200 MSa/s sample rate and 2 MBytes of MegaZoom deep memory per channel.

- **Agilent 54621A** - 2-channel, 60-MHz bandwidth
- **Agilent 54621D** - 2-channel +16 logic channels, 60-MHz bandwidth
- **Agilent 54622A** - 2-channel, 100-MHz bandwidth
- **Agilent 54622D** - 2-channel +16 logic channels, 100-MHz bandwidth
- **Agilent 54624A** - 4-channel, 100-MHz bandwidth

with 2 GSa/s sample rate and 4 MBytes of MegaZoom deep memory per channel.

- **Agilent 54641A** - 2-channel, 350-MHz bandwidth
- **Agilent 54641D** - 2-channel +16 logic channels, 350-MHz bandwidth
- **Agilent 54642A** - 2-channel, 500-MHz bandwidth
- **Agilent 54642D** - 2-channel +16 logic channels, 500-MHz bandwidth

Display shows current input signals

- All analog and digital (54621D/22D/41D/42D) channels displayed in main and delayed mode
- Indicators for channel, time base, digital (54621D/22D/41D/42D) channel activity, trigger and acquisition status
- Softkey labels
- Measurement results

Digital channel controls select, position, and label inputs (54621D/22D/41D/42D)

- Turn channels on or off individually or in groups of 8
- Rearrange order of channels to group related signals
- Create and display labels to identify channels

Run control keys begin and end data acquisition

- Run/Stop starts and stops continuous acquisitions
- Single performs one acquisition
- Infinite persistence accumulates and displays the results of multiple acquisitions

General controls measure, save and restore results, and configure the oscilloscope

- Waveform math including FFT, subtract, multiply, integrate, and differentiate
- Use Quick Meas to make automatic measurements Integrated counter included with Quick Meas.
- Use cursors to make manual measurements
- Save or recall measurement configurations or previous results
- Autoscale performs simple one-button setup of the oscilloscope

Horizontal Controls select sweep speed and delay parameters

- Sweep speeds from 5 ns/div to 50 ns/div (54620-series) and 1 ns/div to 50 s/div (54640-series)
- Delay control moves waveform display to point of interest
- Delayed mode and delay allow zooming in to show a portion of waveform in detail (split screen)

Trigger keys define what data the oscilloscope will trigger on

- Source key allows conventional oscilloscope triggering
- Modes include Edge, Pulse Width, Pattern, CAN, Duration, I²C, LIN, Sequence, SPI, TV, and USB triggering

Softkeys extend the functionality of command keys

Select measurement types, operating modes, trigger specifications, label data, and more

Digital channel inputs through a flexible probing system (54621D/22D/41D/42D)

- Sixteen channels through a dual 8-channel cable with micro-clips
- Set logic levels as TTL, CMOS, ECL, or to a user-definable voltage

Utilities

- Dedicated parallel printer port, controller operation, floppy disk storage

Built in Quick Help system

- Press and hold any key front-panel key or softkey to get help in 11 languages.

In This Book

This manual will guide you in using the oscilloscopes. This manual is organized in the following chapters:

Chapter 1 Getting Started—inspecting, cleaning, and setting up your oscilloscope, using Quick Help.

Chapter 2 Front-panel Overview—A quick start guide to get you familiarize you with the front-panel operation.

Chapter 3 Triggering the Oscilloscope—how to trigger the oscilloscope using all the various modes.

Chapter 4 MegaZoom Concepts and Oscilloscope Operation—acquiring waveforms, horizontal and vertical operation, using digital channels.

Chapter 5 Making Measurements—capturing data, using math function, making measurement with cursors and automatic measurements.

Chapter 6 Utilities—configuring the I/O, print settings, Quick Help, floppy disk operations, user cal and self cal, setting the clock and screen saver.

Chapter 7 Performance Characteristics

1 Getting Started

Setting up the Oscilloscope 1-4

To inspect package contents 1-5

To inspect options and accessories 1-8

To clean the oscilloscope 1-11

To adjust the handle 1-12

To power-on the oscilloscope 1-13

To adjust the waveform intensity 1-14



To connect the oscilloscope analog probes 1-15

To compensate your analog probe 1-16

To use the digital probes (mixed-signal oscilloscope only) 1-17

To connect a printer 1-21

To connect an RS-232 cable 1-21

To verify basic oscilloscope operation 1-22

Getting started using the oscilloscope interface 1-23

Using Quick Help 1-25

Selecting a language for Quick Help when the oscilloscope starts up 1-25

Selecting a language for Quick Help after you have been operating the
oscilloscope 1-26

Loading an updated language file from floppy disk 1-27

2 Front-Panel Overview

Important Oscilloscope Considerations 2-3

54620/40-series Oscilloscope Front Panels 2-7

Front-Panel Operation 2-10

Interpreting the display 2-11

To use analog channels to view a signal 2-12

To use digital channels to view a signal 2-13

To display signals automatically using Autoscale 2-14

To apply the default factory configuration 2-15

To adjust analog channel vertical scaling and position 2-16

To set the vertical expand reference for the analog signal 2-17

Contents

- To set analog channel probe attenuation factor 2-17
- To display and rearrange the digital channels 2-18
- To operate the time base controls 2-19
- To start and stop an acquisition 2-20
- To make a single acquisition 2-20
- To use delayed sweep 2-21
- To make cursor measurements 2-22
- To make automatic measurements 2-23
- To modify the display grid 2-24
- To print the display 2-24

3 Triggering the Oscilloscope

Selecting Trigger Modes and Conditions 3-3

- To select the Mode and Coupling menu 3-3
- To select a trigger mode: Normal, Auto, Auto Level 3-4
- To select trigger Coupling 3-6
- To select Noise Reject and HF Reject 3-6
- To set holdoff 3-7
- External Trigger Input 3-9



Trigger Types 3-11

- To use Edge triggering 3-12
- To use Pulse Width triggering 3-14
- To use Pattern triggering 3-17
- To use CAN triggering 3-19
- To use Duration triggering 3-21
- To use I2C triggering 3-24
- To use LIN triggering 3-29
- To use Sequence triggering 3-31
- To use SPI triggering 3-37
- To use TV triggering 3-42
- To use USB triggering 3-52

The Trigger Out connector 3-54

4 MegaZoom Concepts and Oscilloscope Operation

MegaZoom Concepts 4-3

- Deep Memory 4-4
- Oscilloscope Responsiveness 4-5
- Display Update Rate 4-6
- To setup the Analog channels 4-7
- To setup the Horizontal time base 4-11
- Acquisition Modes 4-17
- Display modes 4-21
- Pan and Zoom 4-23
- To pan and zoom a waveform 4-24

Run/Stop/Single/Infinite Persistence Operation 4-25

- Acquiring Data 4-26
- Memory Depth/Record Length 4-27
- To run and stop an acquisition 4-28
- To take a single trace 4-28
- To capture a single event 4-29
- To use infinite persistence 4-30
- To use infinite persistence to store multiple repetitive events 4-30
- To clear the waveform display 4-31

Configuring the Mixed-Signal Oscilloscope 4-32

- To display digital channels using Autoscale 4-32
- Interpreting the digital waveform display 4-33
- To display and rearrange the digital channels 4-34
- To turn individual channels on and off 4-35
- To force all channels on or all channels off 4-36
- To change the display size of the digital channels 4-36
- To change the logic threshold for digital channels 4-37
- Using Digital Channels to Probe Circuits 4-38

Using Labels on the Mixed-Signal Oscilloscope 4-42

- To turn the label display on or off 4-43
- To assign a predefined label to a channel 4-44
- To define a new label 4-45
- To reset the label library to the factory default 4-47

Contents

Saving and Recalling Traces and Setups 4-48

To Autosave traces and setups 4-49

To save traces and setups to internal memory or to overwrite an existing floppy disk file 4-50

To save traces and setups to a new file on the floppy disk 4-51

To recall traces and setups 4-52

Saving (printing) screen images to floppy disk 4-53

Recalling the factory default setup 4-54

5 Making Measurements

Capturing Data 5-3

To use delayed sweep 5-4

To reduce the random noise on a signal 5-6

To capture glitches or narrow pulses with peak detect and infinite persistence 5-10

To use the Roll horizontal mode 5-12

To use the XY horizontal mode 5-13

Math Functions 5-17

Math Scale and Offset 5-18

Multiply 5-19

Subtract 5-20

Differentiate 5-21

Integrate 5-23

FFT Measurement 5-25

Cursor Measurements 5-31

To make cursor measurements 5-32

Automatic Measurements 5-37

Making automatic measurements 5-38

Setting measurement thresholds 5-39

Making time measurements automatically 5-41

Making Delay and Phase Measurements 5-45

Making voltage measurements automatically 5-47

Making overshoot and preshoot measurements 5-50

6 Utilities

- To configure Quick Help languages 6-3
- To update your instrument to the latest application software 6-5
- To configure a printer 6-6
- To use the floppy disk 6-8
- To set up the I/O port to use a controller 6-9
- To set the clock 6-11
- To set up the screen saver 6-12
- To perform service functions 6-14
- To set other options 6-16

7 Performance Characteristics



- Agilent 54620-series Performance Characteristics 7-3
- Agilent 54640-series Performance Characteristics 7-13

Getting Started

When you use the oscilloscopes to help test and troubleshoot your systems, you may do the following:

- Prepare the oscilloscope by connecting it to power and setting up the handle and screen intensity as desired.
- Define the measurement problem by understanding the parameters of the system you wish to test, and the expected system behavior.
- Set up channel inputs by connecting the probes to the appropriate signal and ground nodes in the circuit under test.
- Define the trigger to reference the waveform data at a specific event of interest.
- Use the oscilloscope to acquire data, either in continuous or single-shot fashion.
- Examine the data and make measurements on it using various features.
- Save the measurement or configuration for later re-use or comparison with other measurements.

Repeat the process as necessary until you verify correct operation or find the source of the problem.

MegaZoom Technology Operates with Untriggered Data

With the MegaZoom technology built into the oscilloscope, you can operate the oscilloscope with untriggered data. All you do is press **Run** or **Single** while in Auto trigger mode, then examine the data to set up a trigger.

The oscilloscope's high-speed display can be used to isolate infrequently changing signals. You can then use the characteristics of these signals to help refine the trigger specification. For more information on triggering, data acquisition, data examination and measurement, and configuration, see the later chapters.

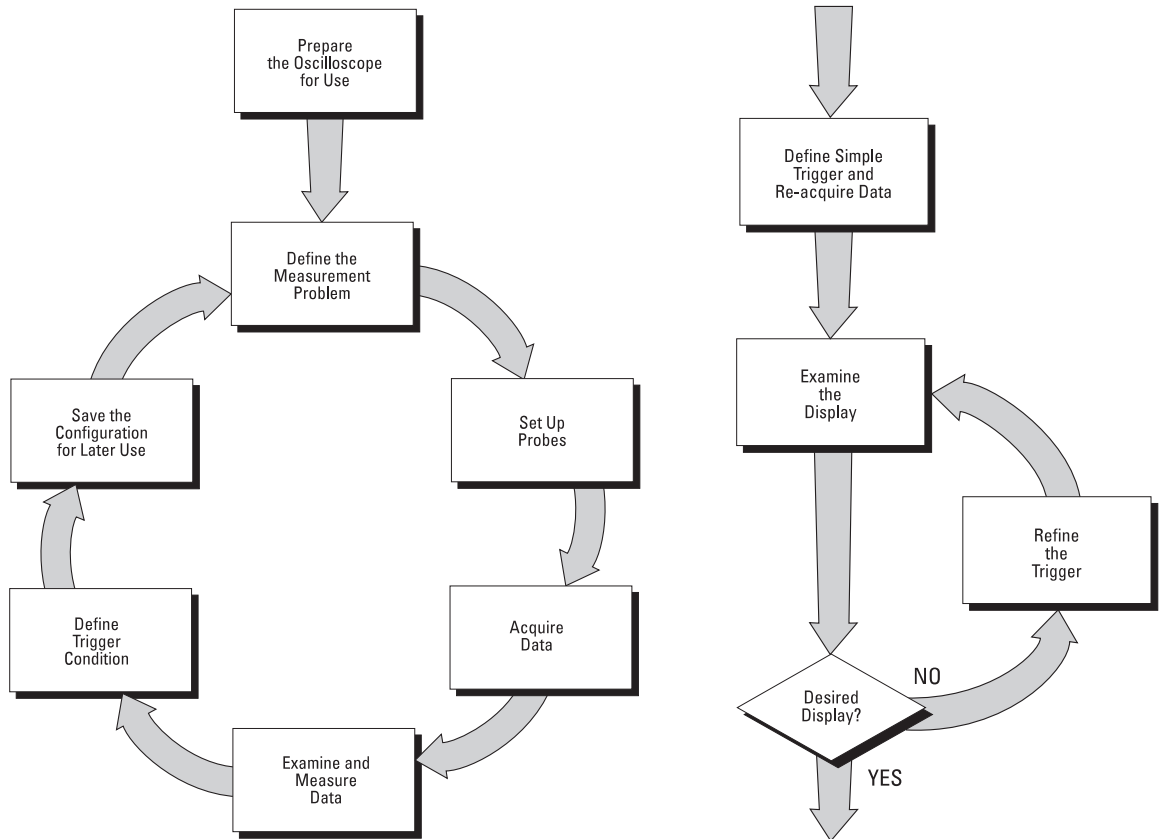

Using the Oscilloscope, and Refining the Trigger Specification

Setting up the Oscilloscope

To prepare your oscilloscope for use, you need to do the following tasks. After you have completed them, you will be ready to use the oscilloscope.

In the following topics you will:

- inspect package contents
- inspect options and accessories
- learn how to clean the oscilloscope
- adjust the handle
- power-on the oscilloscope
- adjust the display intensity
- connect the oscilloscope probes
- connect the digital probes (with 54621D/22D/41D/42D)
- connect a printer
- connect a RS-232 cable
- verify basic oscilloscope operation
- get started using the oscilloscope interface
- learn how to use Quick Help

To inspect package contents

❑ Inspect the shipping container for damage.

If your shipping container appears to be damaged, keep the shipping container or cushioning material until you have inspected the contents of the shipment for completeness and have checked the oscilloscope mechanically and electrically.

❑ Verify that you received the following items and any optional accessories in the oscilloscope packaging (see figure following).

- 54620/40-Series Oscilloscope:
54621A, 21D, 22A, 22D, 24A, 41A, 41D, 42A, or 42D
- 10:1 passive probes with id:
 - (2) 10074C (150 MHz) for 54621A, 21D, 22A, or 22D
 - (4) 10074C (150 MHz) for 54624A
 - (2) 10073C (500 MHz) for 54641A, 41D, 42A, or 42D
- 54620-68701 digital probe kit for 54621D, 22D, 41D, or 42D
- Accessory pouch and front-panel cover standard for all except 54621A, 21D.
(54621A and 21D order N2726A)
- Power cord (see table 1-3)
- IntuiLink for 54600-series Oscilloscopes software and RS-232 cable (all except for 54621A or 21D).

IntuiLink is a Windows application that makes it very easy for you to download images, waveform data, or oscilloscope setups from the oscilloscope to your pc using either Microsoft Word or Microsoft Excel. After installation of IntuiLink, a tool bar in these Microsoft applications will make connection and data transfer from the oscilloscope very simple.

IntuiLink for

IntuiLink for 54600-series Oscilloscopes software is available free on the web at:

www.agilent.com/find/5462xsw
RS-232 cable may be ordered separately, part number 34398A

To inspect package contents

- Agilent IntuiLink Data Capture (all except for 54621A or 21D)

IntuiLink Data Capture is a standalone program for downloading waveform data from the oscilloscopes to your PC via GPIB or RS-232 interface. It provides the capability to transfer deep memory data out of the oscilloscope, allowing up to 4MB (scope channels) and 8MB (logic channels). The IntuiLink for 54600-Series limits the size of acquisition data available to a maximum of 2,000 points regardless of actual number of acquisition points on the screen. With the IntuiLink Data Capture, the amount of points transferred will be the actual number of acquisition points currently displayed or you may select the number of points to download. It provides the following functionality:

- Download waveform data and display the data as a simple chart
- Save the data as binary or text files
- Copy the chart and a selected portion of the data to the clipboard. The maximum data saved to the clipboard is 50,000 point
- Load saved waveform data back into the application

For 54621A and 21D users, IntuiLink Data Capture software is available free on the web at:

www.agilent.com/find/5462xsw

RS-232 cable may be ordered separately, part number 34398A

If anything is missing, contact your nearest Agilent Sales Office. If the shipment was damaged, contact the carrier, then contact the nearest Agilent Sales Office.

Inspect the oscilloscope

- If there is mechanical damage or a defect, or if the oscilloscope does not operate properly or does not pass the performance tests listed in the Service Guide, notify your Agilent Sales Office.
- If the shipping container is damaged, or the cushioning materials show signs of stress, notify the carrier and your Agilent Sales Office. Keep the shipping materials for the carrier's inspection. The Agilent Sales Office will arrange for repair or replacement at Agilent's option, without waiting for claim settlement.

54620/40-Series Oscilloscope

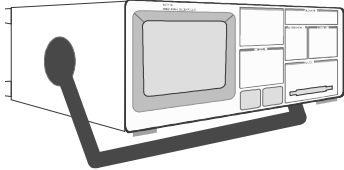

Accessories pouch and front-panel cover**

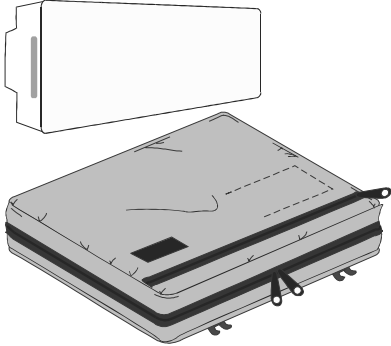

Power cord

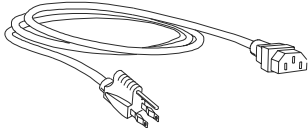

54620-68701 digital probe kit*

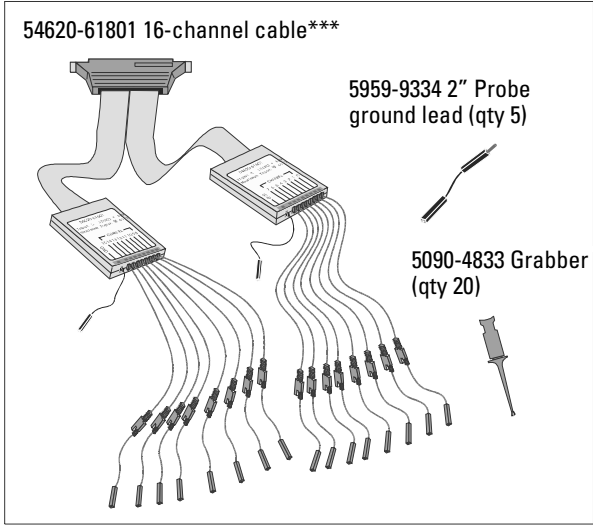

54620-61801 16-channel cable***

5959-9334 2" Probe ground lead (qty 5)



5090-4833 Grabber (qty 20)



IntuiLink for 54600-series software, Data Capture software and serial cable**



10073C or 10074C Probes

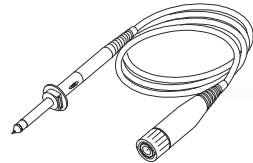

* 54621D /22D/41D/42D only

** All except 54621A/21D

*** The following additional replacement parts (not included) are available for the digital cable:

- 5959-9333 replacement probe leads (qty 5)
- 5959-9335 replacement pod grounds (qty 5)
- 01650-94309 package of probe labels

Package contents for 54620/40-Series Oscilloscopes

To inspect options and accessories

- ❑ Verify that you received the options and accessories you ordered and that none were damaged.

If anything is missing, contact your nearest Agilent Sales Office. If the shipment was damaged, or the cushioning materials show signs of stress, notify the carrier and your Agilent Sales Office.

Some of the options and accessories available for the 54620/40-Series Oscilloscopes are listed in tables 1-1 and 1-2. Contact your Agilent Sales Office for a complete list of options and accessories.

Table 1-1

Options available













Option	Description
003	Shielding Option for use in severe environments or with sensitive devices under test—shields both ways (in and out): RS-03 magnetic interface shielding added to CRT, and RE-02 display shield added to CRT to reduce radiated interference.
1CM	Rackmount kit (same as 1186A)
A6J	ANSII Z540 compliant calibration with test data See table 1-3 for power cord options

Table 1-2

Accessories available	
Model	Description
01650-61607	16:16 logic cable and terminator (for use with 54621D/22D/41D/42D)
54620-68701	16:2 x 8 logic input probe assembly (shipped standard with 54621D/22D/41D/42D)
1146A	Current probe, ac/dc
1183A	Testmobile scope cart
1185A	Carrying Case
1186A	Rackmount Kit
10070C	1:1 Passive Probe with ID
10072A	Fine-pitch probe kit
10075A	0.5 mm IC clip kit
10076A	100:1, 4 kV 250 MHz probe with ID
10100C	50 Ω Termination
10833A	GPIB cable, 1 m long
34398A	RS-232 cable (standard except 54621A/21D)
E2613B	0.5 mm Wedge probe adapter, 3-signal, qty 2
E2614A	0.5 mm Wedge probe adapter, 8-signal, qty 1
E2615B	0.65 mm Wedge probe adapter, 3-signal, qty 2
E2616A	0.65 mm Wedge probe adapter, 8-signal, qty 1
E2643A	0.5 mm Wedge probe adapter, 16-signal, qty 1
E2644A	0.65 mm Wedge probe adapter, 16-signal, qty 1
N2726A	Accessory pouch and front-panel cover (standard except on 54621A/21D)
N2727A	Thermal printer and pouch
N2728A	10 rolls of thermal printer paper
N2757A	GPIB Interface Module
N2758A	CAN Trigger Module
N2772A	20 MHz differential probe
N2773A	Differential probe power supply
N2774A	50 MHz current probe ac/dc
N2775A	Power supply for N2774A

Getting Started
To inspect options and accessories

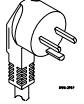
Table 1-3. Power Cords

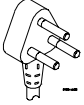
Plug Type	Cable Part Number	Plug Type	Cable Part Number
Opt 900 (U.K.) 	8120-1703	Opt 918 (Japan) 	8120-4754
Opt 901 (Australia) 	8120-0696	Opt 919 (Israel) 	8120-6799
Opt 902 (Europe) 	8120-1692	Opt 920 (Argentina) 	8120-6871
Opt 903 (U.S.A.) 	8120-1521	Opt 921 (Chile) 	8120-6979
Opt 906 (Switzerland) 	8120-2296	Opt 922 (China) 	8120-8377
Opt 912 (Denmark) 	8120-2957	Opt 927 (Thailand) 	8120-8871
Opt 917 (Africa) 	8120-4600		

To clean the oscilloscope

- 1 Disconnect power from the instrument.

CAUTION

Do not use too much liquid in cleaning the oscilloscope. Water can enter the front-panel keyboard, control knobs, or floppy disk damaging sensitive electronic components.

- 2 Clean the oscilloscope with a soft cloth dampened with a mild soap and water solution.
- 3 Make sure that the instrument is completely dry before reconnecting to a power source.

To adjust the handle

- 1 Grasp the handle pivot points on each side of the instrument and pull the pivot out until it stops.

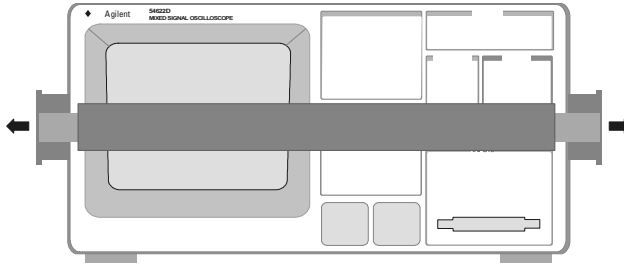

- 2 Without releasing the pivots, swivel the handle to the desired position. Then release the pivots. Continue pivoting the handle until it clicks into a set position.

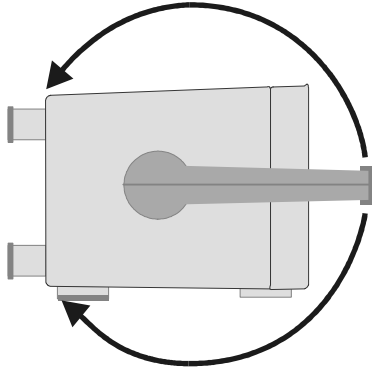

To power-on the oscilloscope

- 1 Connect the power cord to the rear of the oscilloscope, then to a suitable ac voltage source.

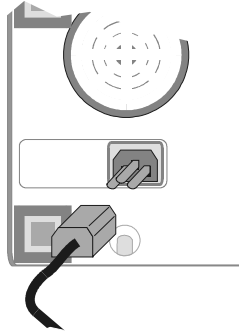

The oscilloscope power supply automatically adjusts for input line voltages in the range 100 to 240 VAC. Therefore, you do not need to adjust the input line voltage setting. The line cord provided is matched to the country of origin. Ensure that you have the correct line cord. See table 1-3

- 2 Press the power switch.

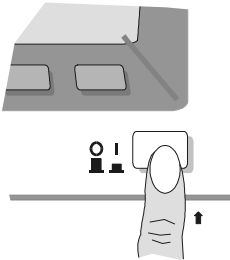

Some front panel key lights will come on and the oscilloscope will be operational in about 5 seconds.

To adjust the waveform intensity

The Intensity control is at the lower left corner of the front panel.

- To decrease waveform intensity, rotate the Intensity control counter-clockwise.
- To increase waveform intensity, rotate the Intensity control clockwise.

Figure 1-1

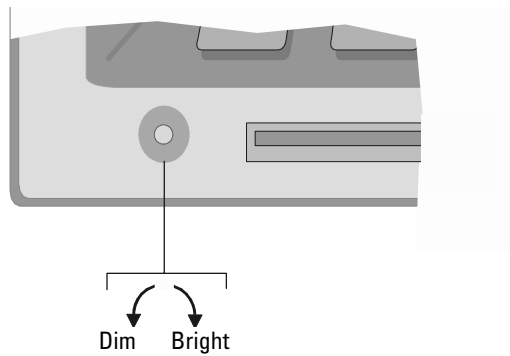

Intensity control

The grid or graticule intensity on the display can be adjusted by pressing the **Display** key, then turn the Entry knob (labeled  on the front panel) to adjust the **Grid** control.

To connect the oscilloscope analog probes

The analog input impedance of these oscilloscopes is selectable either 50Ω (54640-series only) or $1\text{ M}\Omega$. The 50Ω mode matches 50Ω cables commonly used in making high frequency measurements. This impedance matching gives you the most accurate measurements since reflections are minimized along the signal path. The $1\text{ M}\Omega$ mode is for use with probes and for general purpose measurements. The higher impedance minimizes the loading effect of the oscilloscope on the circuit under test.

CAUTION



Do not exceed 5 Vrms in 50Ω mode on the 54640-series models. Input protection is enabled in 50Ω mode and the 50Ω load will disconnect if greater than 5 Vrms is detected. However the inputs could still be damaged, depending on the time constant of the signal.

CAUTION

The 50Ω input protection mode on the 54640-series models only functions when the oscilloscope is powered on.

- 1 Connect the supplied 1.5-meter, 10:1 oscilloscope probe to an analog channel BNC connector input on the oscilloscope.

Maximum input voltage for analog inputs:



CAT I 300 Vrms, 400 Vpk

CAT II 100 Vrms, 400 Vpk

with 10073C or 10074C 10:1 probe: CAT I 500 Vpk, CAT II 400 Vpk

- 2 Connect the retractable hook tip on the probe tip to the circuit point of interest. Be sure to connect the probe ground lead to a ground point on the circuit.

The probe ground lead is connected to the oscilloscope chassis and the ground wire in the power cord. If you need to connect the ground lead to a point in the circuit that cannot be grounded to power ground, consider using a differential probe.

To compensate your analog probe

You should compensate your analog probes to match their characteristics to the oscilloscope. A poorly compensated probe can introduce measurement errors. To compensate a probe, follow these steps:

- 1 Connect the probe from channel 1 to the **Probe Comp** signal on the lower-right corner of the front panel.
- 2 Press **Autoscale**.
- 3 Use a nonmetallic tool to adjust the trimmer capacitor on the probe for the flattest pulse possible.

Perfectly compensated

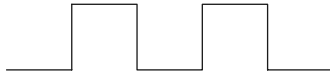

Over compensated



Under compensated



comp.cdr

To use the digital probes (mixed-signal oscilloscope only)

- 1 If you feel it's necessary, turn off the power supply to the circuit under test.

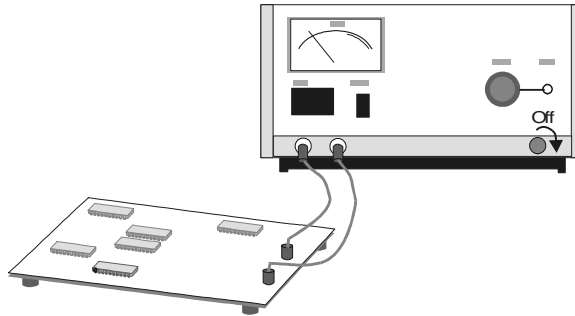

Turning off power to the circuit under test would only prevent damage that might occur if you accidentally short two lines together while connecting probes. You can leave the oscilloscope powered on because no voltage appears at the probes.

- 2 Connect the digital probe cable to D15 - D0 connector on the front panel of the mixed-signal oscilloscope. The digital probe cable is indexed so you can connect it only one way. You do not need to power-off the oscilloscope.

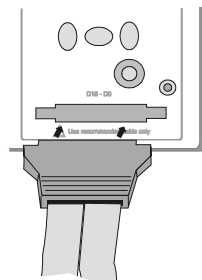

Use only the Agilent part number 54620-68701 digital probe kit supplied with the mixed-signal oscilloscope.

Getting Started

To use the digital probes (mixed-signal oscilloscope only)

- 3 Connect a grabber to one of the probe leads. Be sure to connect the ground lead. (Other probe leads are omitted from the figure for clarity.)

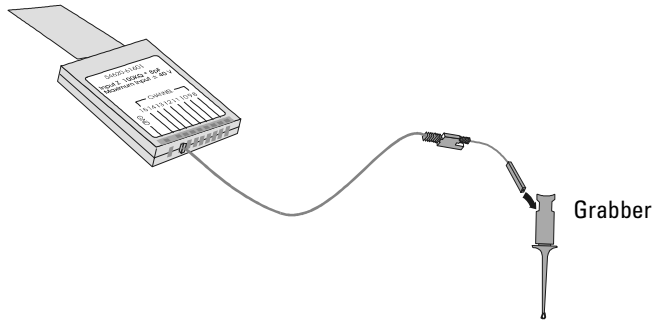

- 4 Connect the grabber to a node in the circuit you want to test.

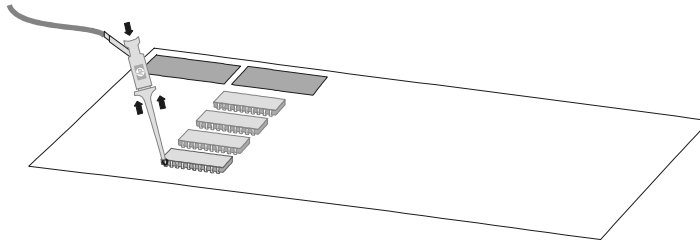

To use the digital probes (mixed-signal oscilloscope only)

- 5 For high-speed signals, connect a ground lead to the probe lead, connect a grabber to the ground lead, and attach the grabber to ground in the circuit under test.

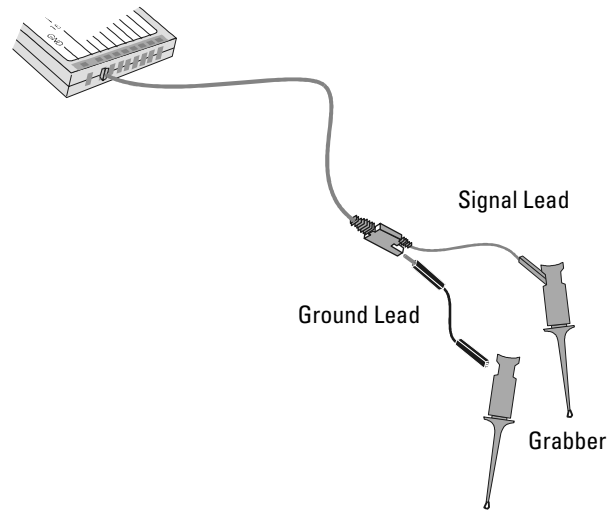

- 6 Connect the ground lead on each set of channels, using a probe grabber. The ground lead improves signal fidelity to the instrument, ensuring accurate measurements.

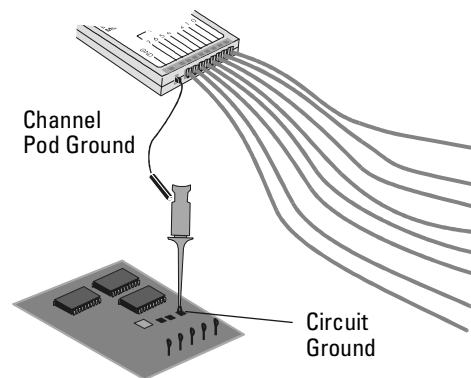

Getting Started

To use the digital probes (mixed-signal oscilloscope only)

- 7 Repeat steps 3 through 6 until you have connected all points of interest.

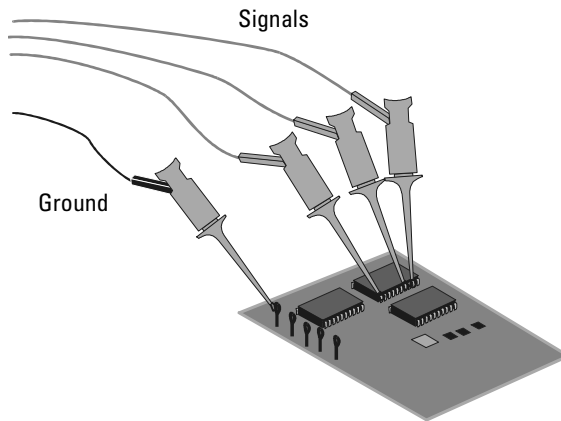

- 8 If you need to remove a probe lead from the cable, insert a paper clip or other small pointed object into the side of the cable assembly, and push to release the latch while pulling out the probe lead.

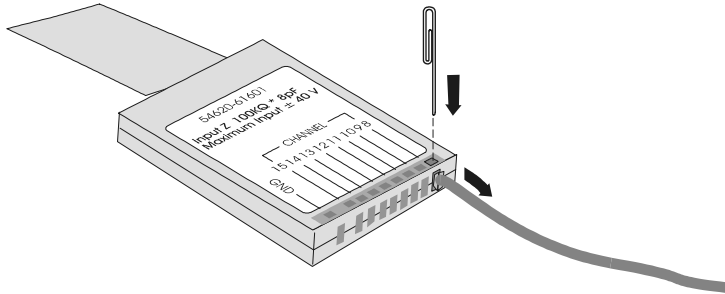

Replacement parts are available. See the Replaceable Parts chapter in the Service Guide for details.

To connect a printer

The oscilloscope connects to a parallel printer through the Parallel output connector on the rear of the oscilloscope. You will need a parallel printer cable to connect to the printer.

- 1 Attach the 25-pin small “D” connector to the Parallel output connector on the rear of the oscilloscope. Tighten the thumbscrews on the cable connector to secure the cable.
- 2 Attach the larger 36-pin “D” connector to the printer.
- 3 Set up the printer configuration on the oscilloscope.
 - a Press the **Utility** key, then press the **Print Confg** softkey.
 - b Press the **Print to:** softkey and set the interface to **Parallel**.
 - c Press the **Format** softkey and select your printer format from the list.

For more information on printer configuration, refer to the “Utilities” chapter.

To connect an RS-232 cable

The oscilloscope can be connected to a controller or a pc through the RS-232 connector on the rear of the oscilloscope. An RS-232 cable is shipped with each oscilloscope except 54621A/21D and may be purchased for the 54621A/21D oscilloscopes.

- 1 Attach the 9-pin “D” connector on the RS-232 cable to the RS-232 connector on the rear of the oscilloscope. Tighten the thumbscrews on the cable connector to secure the cable
- 2 Attach the other end of the cable to your controller or pc.
- 3 Set up the RS-232 configuration on the oscilloscope.
 - a Press the **Utility** key, then press the **I/O** softkey.
 - b Press the **Controller** softkey and select **RS-232**.
 - c Press the **Baud** softkey and set the baud rate to match your controller or pc.
 - d Press the **XON DTR** softkey and set the handshake to match your controller or pc.

For more information on RS-232 configuration, refer to the “Utilities” chapter.

To verify basic oscilloscope operation

- 1 Connect an oscilloscope probe to channel 1.
- 2 Attach the probe to the Probe Comp output on the lower-right side of the front panel of the oscilloscope.

Use a probe retractable hook tip so you do not need to hold the probe.

- 3 Press the **Save/Recall** key on the front panel, then press the **Default Setup** softkey under the display.

The oscilloscope is now configured to its default settings.

- 4 Press the **Autoscale** key on the front panel.

You should then see a square wave with peak-to-peak amplitude of about 5 divisions and a period of about 4 divisions as shown below. If you do not see the waveform, ensure your power source is adequate, the oscilloscope is properly powered-on, and the probe is connected securely to the front-panel channel input BNC and to the Probe Comp calibration output.

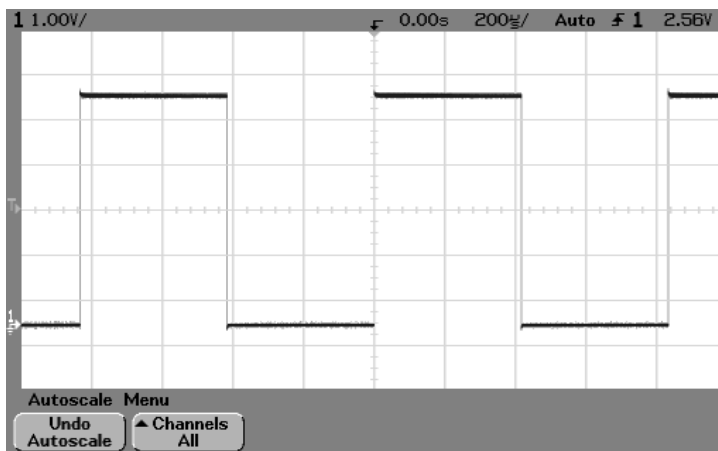

Verifying Basic Oscilloscope Operation

Getting started using the oscilloscope interface

When the oscilloscope is first turned on, a startup screen is displayed as shown below.

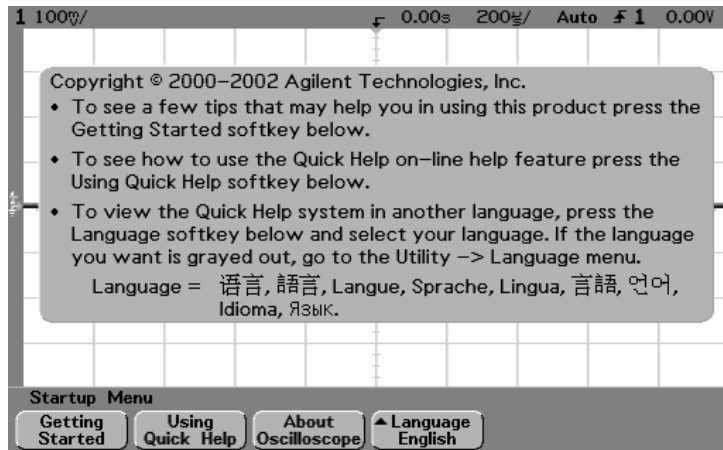

This menu is only accessible when the oscilloscope first starts up.

To verify basic oscilloscope operation

- Press the **Getting Started** softkey to view the symbols used in the oscilloscope softkey menus.

 Use the Entry knob labeled  to adjust the parameter.

 Press the softkey to display a pop up with a list of choices. Repeatedly press the softkey until your choice is selected.

 Use the Entry knob labeled  or press the softkey to adjust the parameter.

 Option is selected and operational.

 Feature is on. Press the softkey again to turn the feature off.

 Feature is off. Press the softkey again to turn the feature on.

 Links you to another menu.

 Press the softkey to view the menu.

 Press the softkey to return to the previous menu.

Using Quick Help

The oscilloscope has a Quick Help system that provides user help for each front-panel key and softkey on the oscilloscope. To view Quick Help information:

- 1 Press and hold down the key for which you would like to view help.
- 2 Release the key after reading the message. Releasing the key returns the oscilloscope to the previous state.

Selecting a language for Quick Help when the oscilloscope starts up

When the oscilloscope first powers up, you can press the **Language** softkey to select a language for viewing Quick Help. Successively press the **Language** softkey until the desired language in the list is selected.

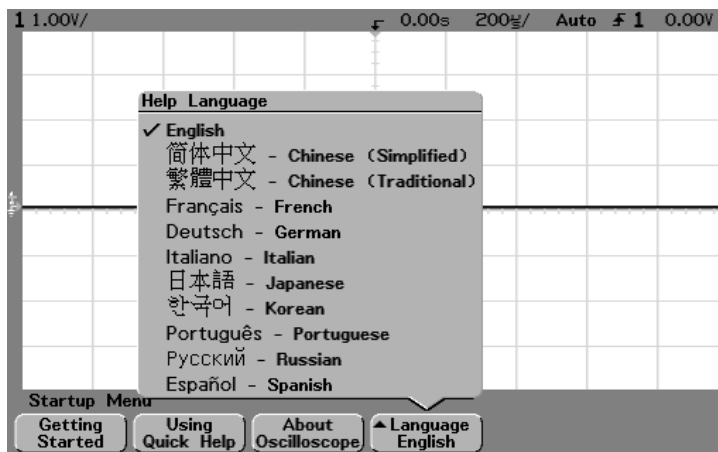

You can also select a language later from the **Utility Language** menu.

Selecting a language for Quick Help after you have been operating the oscilloscope

Selecting a language for Quick Help after you have been operating the oscilloscope

- 1 Press the **Utility** key, then press the **Language** softkey to display the Language menu.
- 2 Press the **Language** softkey until the desired language in the list is selected.

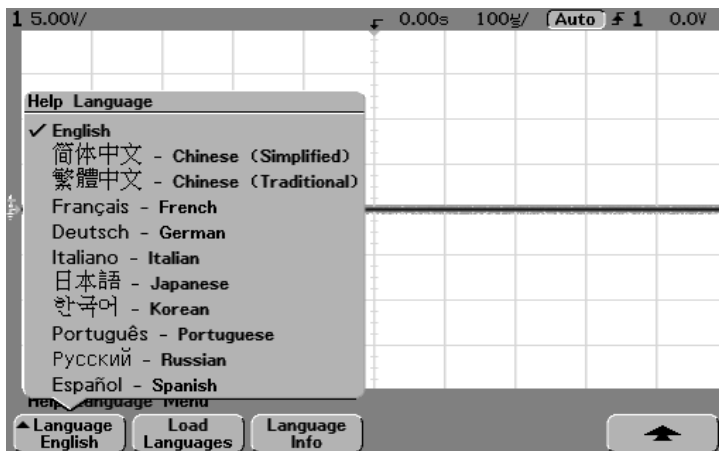

When updates occur, an updated language file can be downloaded from:
www.agilent.com/find/5462xsw for the 54620-series or
www.agilent.com/find/5464xsw for the 54640-series,
or call an Agilent center and request a language disk for your instrument

Loading an updated language file from floppy disk

When updates occur, an updated language file can be downloaded from:

www.agilent.com/find/5462xsw for the 54620-series or

www.agilent.com/find/5464xsw for the 54640-series,

or call an Agilent center and request a language disk for your instrument.

- 1 Insert the floppy disk containing the language file into the floppy disk drive on the oscilloscope.
- 2 Press the **Utility** key, then press the **Language** softkey to display the Language menu.
- 3 Press the **Load Languages** softkey to load the updated language file into the oscilloscope.
- 4 Press the **Language** softkey and select the language to be viewed.

For more information about loading languages, refer to the “Utilities” chapter.

Front-Panel Overview

Front-Panel Overview

Before you make measurements using the Agilent 54620-series and 54640-series Oscilloscopes, you must first set up the instrument using front-panel controls. Then, make the measurement and read the display results.

These oscilloscopes operate much like an analog scope, but they can do much more. Spending a few minutes to learn some of these capabilities will take you a long way toward more productive troubleshooting. The “MegaZoom Concepts and Oscilloscope Operation” chapter has more detail on the things to consider while operating your oscilloscope.

The keys on the front panel bring up softkey menus on the display that allow access to oscilloscope features. Many softkeys use the Entry knob  to select values.

Throughout this book, the front-panel keys and softkeys are denoted by a change in the text type. For example, the **Cursors** key is on the front panel and the **Normal** softkey appears at the bottom of the display directly above its corresponding key. Other softkey graphic conventions used on the oscilloscope and throughout this guide are shown in the “Getting started using the oscilloscope interface” topic in chapter 1.

Important Oscilloscope Considerations

Using Single versus Run/Stop

The oscilloscopes have a **Single** key and a **Run/Stop** key. When you press **Run** (key is illuminated in green), the trigger processing and screen update rate are optimized over the memory depth. Single acquisitions always use the maximum memory available—at least twice as much memory as acquisitions captured in Run mode—and the scope stores at least twice as many samples. At slow sweep speeds, the oscilloscope operates at a higher sample rate when Single is used to capture an acquisition, as opposed to running, due to the increased memory available.

Using Auto trigger mode versus Normal trigger mode

Normal trigger mode requires a trigger to be detected before an acquisition can complete. In many cases, a triggered display is not needed to check signal levels or activity. For these applications, use Auto trigger mode. If you only want to acquire specific events as specified by the trigger settings, use Normal trigger mode. For more detailed discussion of Auto trigger mode and Normal trigger mode, refer to Chapter 3, “*Triggering the Oscilloscope.*”

Viewing signal detail with acquire mode

Remember how you had to constantly adjust the brightness on old analog scopes to see a desired level of detail in a signal, or to see the signal at all? With the Agilent 54620/40-series oscilloscopes, this is not necessary. The Intensity knob operates much like the brightness knob on your computer screen, so you should set it to a level that makes for comfortable viewing, given the room lighting, and leave it there. Then you can control the detail by selecting an Acquire mode: Normal, Peak Detect, Average, or Realtime as described in the following paragraphs.

Normal acquire mode Normal mode is the acquisition mode that you will probably use for acquiring samples most of the time. It compresses up to 2 million acquisition points per channel for the 54620-series and up to 4 million acquisition points per channel for the 54640-series into a 1,000-pixel column display record.

The 54620-series 200 MSa/s sampling speed specification means that samples are taken every 5 ns. The 54640-series 2 GSa/s sampling speed specification means that samples are taken every 500 ps. At the faster sweep speeds, the running display is built from many individual triggers. If you press the **Stop** key, and pan and zoom through the waveform by using the Horizontal and Vertical knobs, only the last trigger’s acquisition will be displayed.

Important Oscilloscope Considerations

Whether the oscilloscope is stopped or running, you see more detail as you zoom in, and less as you zoom out. Zoom means you expand the waveform using either the main or delayed sweep window. Panning the waveform means you use the Horizontal Delay time knob(◀▶)to move it horizontally. To keep from losing detail as you zoom out, switch to the Peak Detect acquisition mode.

Peak Detect acquire mode Peak Detect for the 54620-series and for the 54640-series functions as follows:

- **54620-series** In Peak Detect acquisition mode, any noise, peak, or signal wider than 5 ns will be displayed, regardless of sweep speed. In Normal acquisition mode, at sweep speeds faster than 1 ms/div, you would see a 5-ns peak, so peak detect has no effect at sweep speeds faster than 1 ms/div.
- **54640-series** In Peak Detect acquisition mode, any noise, peak, or signal wider than 1 ns will be displayed, regardless of sweep speed. In Normal acquisition mode, at sweep speeds faster than 500 μ s/div, you would see a 1-ns peak, so peak detect has no effect at sweep speeds faster than 500 μ s/div.

Using Peak Detect and infinite persistence together is a powerful way to find spurious signals and glitches.

Average acquire mode Averaging is a way to pull a repetitive signal out of noise. Averaging works better than either a brightness control or a bandwidth limit because the bandwidth is not reduced except when in high resolution mode (number of averages=1) is selected.

The simplest averaging is high-resolution mode (number of averages = 1). For example, on the 54620-series, the sample rate at a Time/Div setting of 2 ms/div allows the extra 5-ns samples to be smoothed together, smoothing the data into one sample, which is then displayed. Averaging (number of averages > 1) needs a stable trigger, because in this mode multiple acquisitions are averaged together. See the “MegaZoom Concepts and Oscilloscope Operation” chapter for more information about high resolution mode.

Realtime acquire mode In Realtime mode, the oscilloscope produces the waveform display from samples collected during one trigger event. The sample rate for the 54620-series is 200 MSa/s for single channel or 100 MSa/s with channel pairs 1 and 2, 3 and 4, or pod 1 and pod 2 running. The sample rate for the 54640-series is 2 GSa/s for single channel or 1 GSa/s with channel pairs 1 and 2, or pod 1 and pod 2 running.

When less than 1000 samples can be collected in the time spanned by the screen, a sophisticated reconstruction filter is used to fill in and enhance the waveform display.

To accurately reproduce a sampled waveform, the sample rate should be at least four times the highest frequency component of the waveform. If not, it is possible for the reconstructed waveform to be distorted or aliased. Aliasing is most commonly seen as jitter on fast edges.

When Realtime mode is off, the oscilloscope produces the waveform display from samples collected from multiple triggers, when on fast sweep speeds. In this case, the reconstruction filter is not used. When the trigger is stable, this produces the highest fidelity waveform.

Realtime mode is only necessary at sweep speeds of 200 ns/div and faster for the 54620-series and 2 μ s/div and faster for the 54640-series, since on these ranges <1000 samples can be collected on each trigger. While the effective bandwidth of the channel is reduced slightly, Realtime mode produces a complete waveform for each trigger.

Realtime can be turned on when any other acquisition mode is turned on. Use Realtime to capture infrequent triggers, unstable triggers, or complex changing waveforms, such as eye diagrams.

Using Vectors (Display menu)

One of the most fundamental choices you must make about your display is whether to draw vectors (connect the dots) between the samples, or simply let the samples fill in the waveform. To some degree, this is a matter of personal preference, but it also depends on the waveform.

- You will probably operate the oscilloscope most often with vectors on. Complex analog signals like video and modulated signals show analog-like intensity information with vectors on.
- Turn vectors off when the maximum display rate is required, or when highly complex or multi-valued waveforms are displayed. Turning vectors off may aid the display of multivalued waveforms such as eye diagrams.

Important Oscilloscope Considerations

Delayed Sweep

Delayed sweep is a simultaneous display of the waveform at two different sweep speeds. Because of the deep memory in the MegaZoom technology, it is possible to capture the main display at 1 ms/div, and redisplay the same trigger in the delayed display at any desired faster time base.

There is no limit imposed on the zoom ratio between the main and delayed displays. There is, however, a useful limit when the samples are spaced so far apart that they are of little value. See the “MegaZoom Concepts and Oscilloscope Operation” chapter for more information about delayed sweep and time reference.

Post Acquisition Processing

In addition to changing display parameters after the acquisition, you can do all of the measurements and math functions after the acquisition. Measurements and math functions will be recalculated as you pan and zoom and turn channels on and off. As you zoom in and out on a signal using the horizontal sweep speed knob and vertical volts/division knob, you affect the resolution of the display. Because measurements and math functions are performed on displayed data, you affect the resolution of functions and measurements.

54620/40-series Oscilloscope Front Panels

Figure 2-1

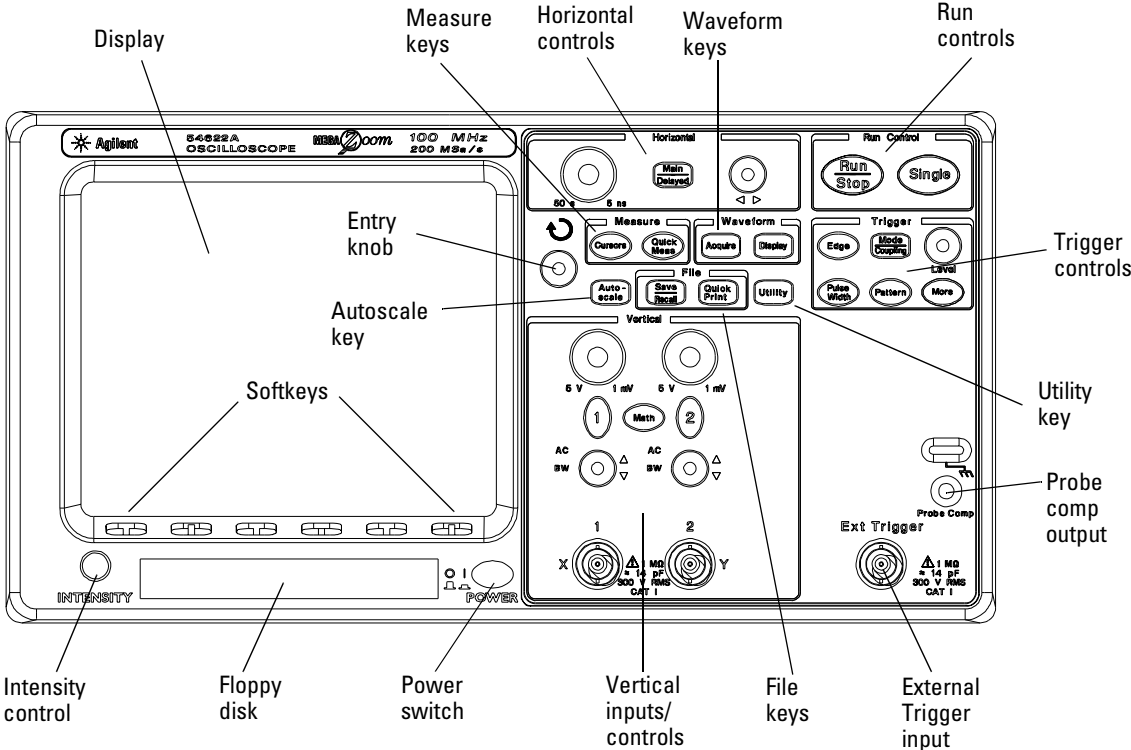

54621A, 54622A, 54641A, and 54642A 2-Channel Oscilloscopes Front Panel

Front-Panel Overview

54620/40-series Oscilloscope Front Panels

Figure 2-2

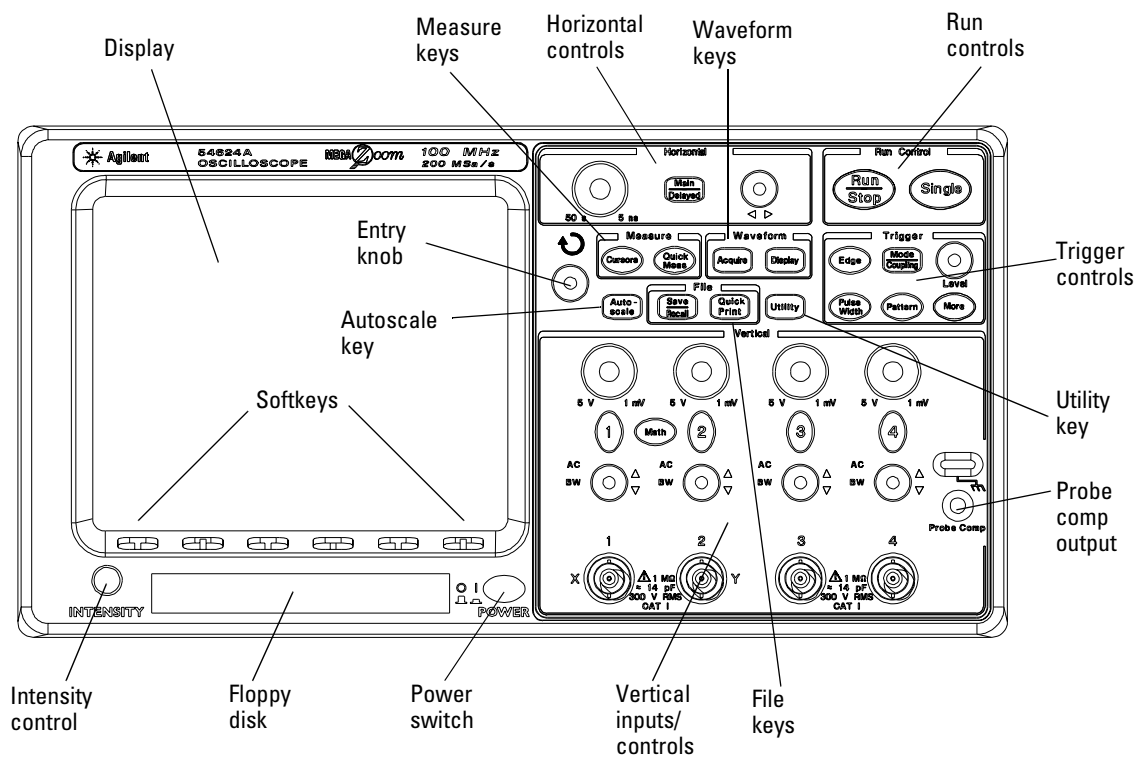

54624A 4-Channel Oscilloscope Front Panel

Figure 2-3

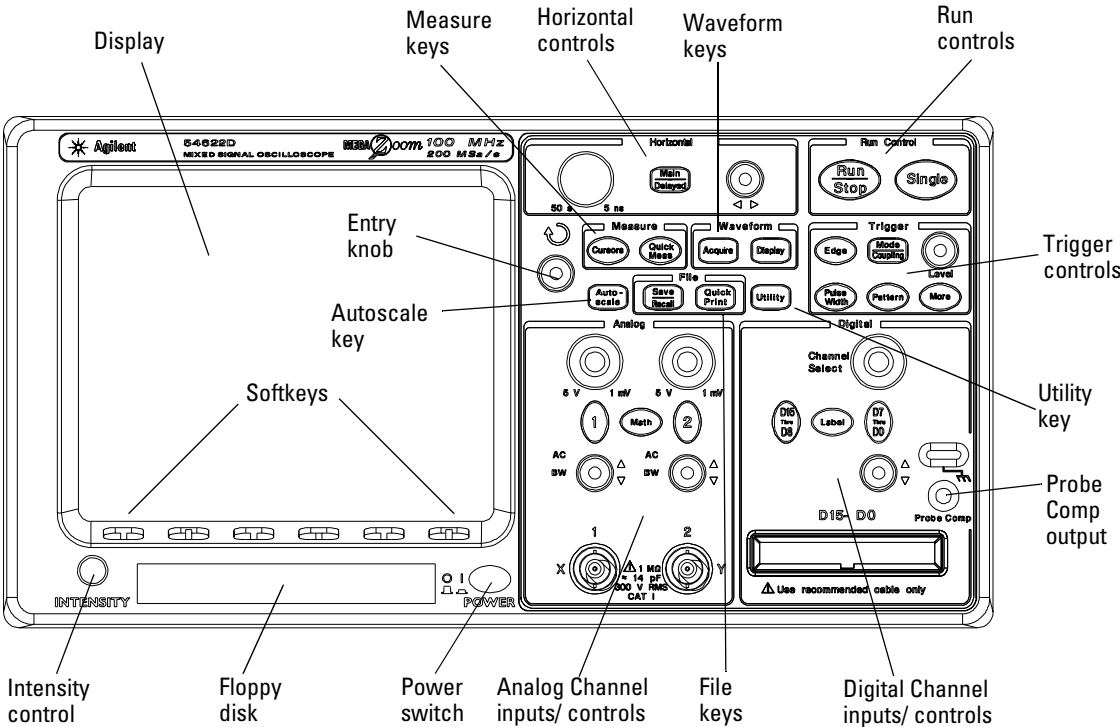

54621D, 54622D, 54641D, and 54642D Mixed-Signal Oscilloscopes Front Panel

Front-Panel Operation

This chapter provides a brief overview of interpreting information on the display and an introduction to operating the front-panel controls. Detailed oscilloscope operating instructions are provided in later chapters.

54621D, 54622D, 54641D, and 54642D digital channels

Because all of the oscilloscopes in the 54620/40-series have analog channels, the analog channel topics in this chapter apply to all instruments. Whenever a topic discusses the digital channels, that information applies only to the 54621D, 54622D, 54641D, or 54642D Mixed-Signal Oscilloscopes.

Interpreting the display

The oscilloscope display contains channel acquisitions, setup information, measurement results, and softkeys for setting up parameters.

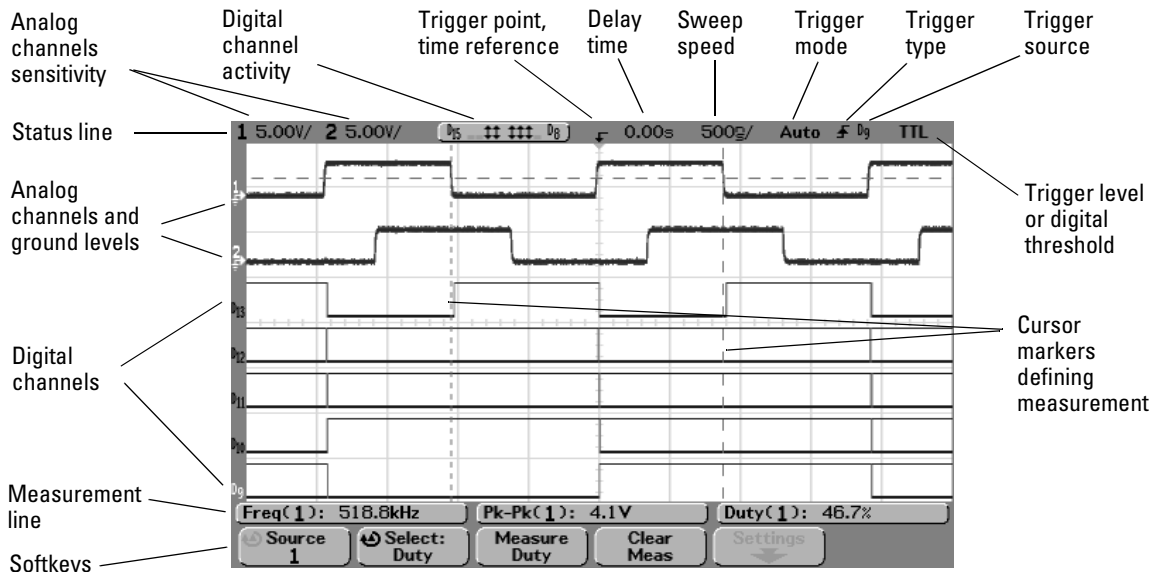

Interpreting the display

Status line The top line of the display contains vertical, horizontal, and trigger setup information.

Display area The display area contains the waveform acquisitions, channel identifiers, and analog trigger and ground level indicators.

Measurement line This line normally contains automatic measurement and cursor results, but can also display advanced trigger setup data and menu information.

Softkeys The softkeys allow you to set up additional parameters for front-panel keys.

To use analog channels to view a signal

- To configure the oscilloscope quickly, press the **Autoscale** key to display the connect signal.
- To undo the effects of Autoscale, press the **Undo Autoscale** softkey before pressing any other key.

This is useful if you have unintentionally pressed the **Autoscale** key or do not like the settings Autoscale has selected and want to return to your previous settings.

- To set the instrument to the factory-default configuration, press the **Save/Recall** key, then press the **Default Setup** softkey.

Example

Connect the oscilloscope probes for channels 1 and 2 to the Probe Comp output on the front panel of the instrument. Be sure to connect the probe ground leads to the lug above the Probe Comp output. Set the instrument to the factory default configuration by pressing the **Save/Recall** key, then the **Default Setup** softkey. Then press the **Autoscale** key. You should see a display similar to the following.

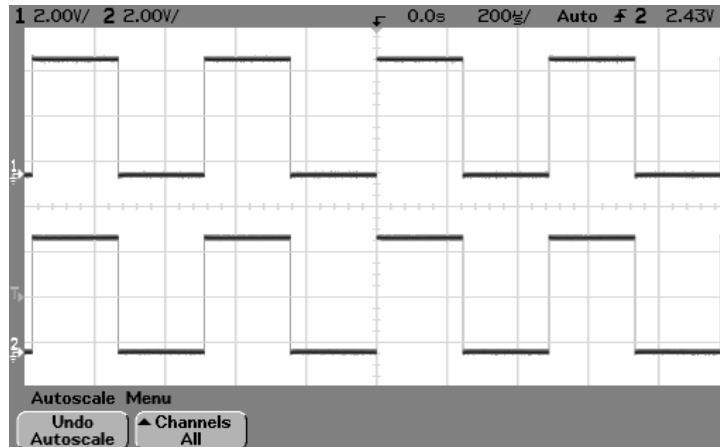

Autoscale with analog channels

To use digital channels to view a signal

- To configure the oscilloscope quickly, press the **Autoscale** key to display the connected signals.
- To undo the effects of Autoscale, press the **Undo Autoscale** softkey before pressing any other key.

This is useful if you have unintentionally pressed the **Autoscale** key or do not like the settings Autoscale has selected and want to return to your previous settings.

- To set the instrument to the factory-default configuration, press the **Save/Recall** key, then press the **Default Setup** softkey.

Example

Install probe clips on channels 0 and 1 on the digital probe cable. Connect the probes for digital channels 0 and 1 to the Probe Comp output on the front panel of the instrument. Be sure to connect the ground lead. Set the instrument to the factory default configuration by pressing the **Save/Recall** key, then the **Default Setup** softkey. Then press the **Autoscale** key. You should see a display similar to the following.

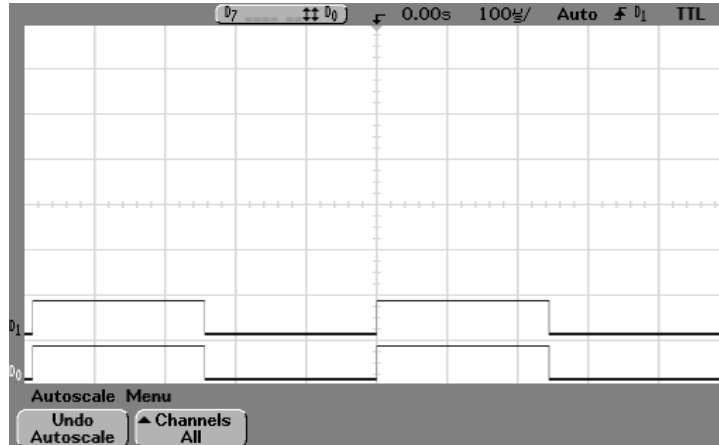

Autoscale with digital channels (54621D, 54622D, 54641D, and 54642D)

To display signals automatically using Autoscale

- To configure the instrument quickly, press the **Autoscale** key.

Autoscale displays all connected signals that have activity.

To undo the effects of Autoscale, press the **Undo Autoscale** softkey before pressing any other key.

How Autoscale Works

Autoscale automatically configures the oscilloscope to best display the input signal by analyzing any waveforms connected to the external trigger and channel inputs. Autoscale finds, turns on, and scales any channel with a repetitive waveform with a frequency of at least 50 Hz, a duty cycle greater than 0.5%, and an amplitude of at least 10 mV peak-to-peak. Any channels that do not meet these requirements are turned off.

The trigger source is selected by looking for the first valid waveform starting with external trigger, then continuing with the highest number analog channel down to the lowest number analog channel, and finally (if applicable) the highest number digital channel.

During Autoscale, the delay is set to 0.0 seconds, the sweep speed setting is a function of the input signal (about 2 periods of the triggered signal on the screen), and the triggering mode is set to edge. Vectors remain in the state they were before the Autoscale.

Undo Autoscale

Press the **Undo Autoscale** softkey to return the oscilloscope to the settings that existed before you pressed the **Autoscale** key.

This is useful if you have unintentionally pressed the **Autoscale** key or do not like the settings Autoscale has selected and want to return to your previous settings.

The **Channels** softkey selection determines which channels will be displayed on subsequent Autoscales.

All Channels - The next time you press **Autoscale**, all channels that meet the requirements of Autoscale will be displayed.

Only Displayed Channels - The next time you press **Autoscale**, only the channels that are turned on will be displayed. This is useful if you only want to view specific active channels after pressing **Autoscale**.

To apply the default factory configuration

- To set the instrument to the factory-default configuration, press the **Save/Recall** key, then press the **Default Setup** softkey.

The default configuration returns the oscilloscope to its default settings. This places the oscilloscope in a known operating condition. The major default settings are:

Horizontal main mode, 100 us/div scale, 0 s delay, center time reference

Vertical (Analog) Channel 1 on, 5 V/div scale, dc coupling, 0 V position, 1 M Ω impedance, probe factor to 1.0 if an AutoProbe probe is not connected to the channel

Trigger Edge trigger, Auto sweep mode, 0 V level, channel 1 source, dc coupling, rising edge slope, 60 ns holdoff time

Display Vectors on, 20% grid intensity, infinite persistence off

Other Acquire mode normal, Run/Stop to Run, cursors and measurements off

Labels all custom labels in the Label Library are erased

To adjust analog channel vertical scaling and position

This exercise guides you through the vertical keys, knobs, and status line.

1 Center the signal on the display using the position knob.

The position knob (◆) moves the signal vertically; the signal is calibrated. Notice that as you turn the position knob, a voltage value is displayed for a short time, indicating how far the reference (⚡) is located from the center of the screen. Also notice that the ground reference symbol at the left edge of the display moves with the position knob.

Measurement Hints

If the channel is DC coupled, you can quickly measure the DC component of the signal by simply noting its distance from the ground symbol.

If the channel is AC coupled, the DC component of the signal is removed, allowing you to use greater sensitivity to display the AC component of the signal.

2 Change the vertical setup and notice that each change affects the status line differently. You can quickly determine the vertical setup from the status line in the display.

- Change the vertical sensitivity with the large volts/division knob in the Vertical (Analog) section of the front panel and notice that it causes the status line to change.
- Press the **1** key.

If channel 1 was not turned on, a softkey menu appears on the display, and the channel turns on (the **1** key will be illuminated).

If channel 1 was already turned on, but another menu was being displayed, the softkeys will now display the channel 1 menu.

When Vernier is turned off, the volts/div knob can change the channel sensitivity in a 1-2-5 step sequence. When Vernier is selected, you can change the channel sensitivity in smaller increments with the volts/division knob. The channel sensitivity remains fully calibrated when Vernier is on. The sensitivity value is displayed in the status line at the top of the display.

- To turn the channel off, press the channel **1** key until the key is not illuminated.

To set the vertical expand reference for the analog signal

When changing the volts/division for analog channels, you can have the signal expand (or compress) about the signal ground point or about the center graticule on the display. This works well with two signals displayed, because you can position and see them both on the screen while you change the amplitude.

- To expand the signal about the center graticule of the display, press the **Utility** key, press the **Options** softkey, then press the **Expand** softkey and select **Expand About Center**.

With **Expand About Center** selected, when you turn the volts/division, the waveform will expand or contract about the center graticule of the display.

- To expand the signal about the position of the channel's ground, press the **Utility** key, press the **Options** softkey. Then press the **Expand** softkey and select **Expand About Ground**.

With **Expand About Ground** selected, when you turn the volts/division knob, the ground level of the waveform remains at the same point on the display, while the non-ground portions of the waveform expand or contract.

To set analog channel probe attenuation factor

If you have an AutoProbe self-sensing probe (such as the 10073C or 10074C) connected to the analog channel, the oscilloscope will automatically configure your probe to the correct attenuation factor.

If you do not have an AutoProbe probe connected, you can press the channel key, then press the **Probe** submenu softkey, then turn the Entry knob  to set the attenuation factor for the connected probe. The attenuation factor can be set from 0.1:1 to 1000:1 in a 1-2-5 sequence.

The probe correction factor must be set properly for measurements to be made correctly.

To display and rearrange the digital channels

- 1 Press the **D15 Thru D8** key or **D7 Thru D0** key to turn the display of the digital channels on or off.

The digital channels are displayed when these keys are illuminated.

- 2 Turn the Digital Channel Select knob to select a single digital channel.

The selected channel number is highlighted on the left side of the display.

- 3 Turn the Digital position knob (◆) to reposition the selected channel on the display.

If two or more channels are displayed at the same position, a pop up will appear showing the overlaid channels. Continue turning the Channel Select knob until the desired channel within the pop up is selected.

To operate the time base controls

The following exercise guides you through the time base keys, knobs, and status line.

- Turn the **Horizontal sweep speed (time/division)** knob and notice the change it makes to the status line.

The sweep speed knob changes the sweep speed from 5 ns/div to 50 s/div for the 54620-series and 1 ns/div to 50 s/div for the 54640-series in a 1-2-5 step sequence, and the value of the sweep speed is displayed in the status line at the top of the display.

- Press the **Main/Delayed**, then press the **Vernier** softkey.

The **Vernier** softkey allows you to change the sweep speed in smaller increments with the time/div knob. These smaller increments are calibrated, which results in accurate measurements, even with the vernier turned on.

- Turn the **delay time knob (◀▶)** and notice that its value is displayed in the status line.

The delay knob moves the main sweep horizontally, and it pauses at 0.00 s, mimicking a mechanical detent. At the top of the graticule is a solid triangle (▼) symbol and an open triangle (∇) symbol. The ▼ symbol indicates the trigger point and it moves with the Delay time knob. The ∇ symbol indicates the time reference point and is also where the zoom-in/zoom-out is referenced. If the **Time Ref** softkey is set to **Left**, the ∇ is located one graticule in from the left side of the display. If the **Time Ref** softkey is set to **Center**, the ∇ is located at the center of the display. If the **Time Ref** softkey is set to **Right**, the ∇ is located one graticule in from the right side of the display. The delay number tells you how far the time reference point ∇ is located from the trigger point ▼.

All events displayed left of the trigger point ▼ happened before the trigger occurred, and these events are called pre-trigger information. You will find this feature very useful because you can now see the events that led up to the trigger point. Everything to the right of the trigger point ▼ is called post-trigger information. The amount of delay range (pre-trigger and post-trigger information) available depends on the sweep speed selected.

To start and stop an acquisition

- When the **Run/Stop** key is illuminated in green, the oscilloscope is in continuous running mode.
You are viewing multiple acquisitions of the same signal similar to the way an analog oscilloscope displays waveforms.
 - When the **Run/Stop** key is illuminated in red, the oscilloscope is stopped. “Stop” is displayed in the trigger mode position in status line at the top of the display. You may now pan and zoom the stored waveform by turning the Horizontal and Vertical knobs.
The stopped display may contain several triggers worth of information, but only the last trigger acquisition is available for pan and zoom. To ensure the display does not change, use the **Single** key to be sure you have acquired only one trigger.
 - The **Run/Stop** key may flash between a user requesting a **Stop** and the completion of the current acquisition.
-

To make a single acquisition

The Single run control key lets you view single-shot events without subsequent waveform data overwriting the display. Use Single when you want maximum memory depth for pan and zoom and you want the maximum sample rate.

- 1 First set trigger **Mode/Coupling Mode** softkey to **Normal**.
This keeps the oscilloscope from autotriggering immediately.
 - 2 If you are using the analog channels to capture the event, turn the Trigger Level knob to the trigger threshold where you think the trigger should work.
 - 3 To begin a single acquisition, press the **Single** key.
When you press Single, the display is cleared, the trigger circuitry is armed, the Single key is illuminated, and the oscilloscope will wait until a trigger condition occurs before it displays a waveform.
When the oscilloscope triggers, the single acquisition is displayed and the oscilloscope is stopped (**Run/Stop** key is illuminated in red). Press **Single** again to acquire another waveform.
-

To use delayed sweep

Delayed sweep is an expanded version of main sweep. When Delayed mode is selected, the display divides in half and the delayed sweep  icon displays in the middle of the line at the top of the display. The top half displays the main sweep and the bottom half displays the delayed sweep.

The following steps show you how to use delayed sweep. Notice that the steps are very similar to operating the delayed sweep in analog oscilloscopes.

- 1 Connect a signal to the oscilloscope and obtain a stable display.
- 2 Press **Main/Delayed**.
- 3 Press the **Delayed** softkey.

To change the sweep speed for the delayed sweep window, turn the sweep speed knob. As you turn the knob, the sweep speed is highlighted in the status line above the waveform display area.

The area of the main display that is expanded is intensified and marked on each end with a vertical marker. These markers show what portion of the main sweep is expanded in the lower half. The Horizontal knobs control the size and position of the delayed sweep. The delay value is momentarily displayed in the upper-right portion of the display when the delay time (◀▶) knob is turned.

Delayed sweep is a magnified portion of the main sweep. You can use delayed sweep to locate and horizontally expand part of the main sweep for a more detailed (higher-resolution) analysis of signals.

To change the sweep speed for the main sweep window, press the **Main** softkey, then turn the sweep speed knob.

To make cursor measurements

You can use the cursors to make custom voltage or time measurements on scope signals, and timing measurements on digital channels.

- 1 Connect a signal to the oscilloscope and obtain a stable display.
- 2 Press the **Cursors** key. View the cursor functions in the softkey menu:

Mode Set the cursors results to measure voltage and time (Normal), or display the binary or hexadecimal logic value of the displayed waveforms.

Source selects a channel or math function for the cursor measurements.

X Y Select either the X cursors or the Y cursors for adjustment with the Entry knob.

X1 and X2 adjust horizontally and normally measure time.

Y1 and Y2 adjust vertically and normally measure voltage.

X1 X2 and Y1 Y2 move the cursors together when turning the Entry knob.

For more information about using cursors for measurements, refer to the “Making Measurements” chapter.

To make automatic measurements

You can use automatic measurements on any channel source or any running math function. Cursors are turned on to focus on the most recently selected measurement (right-most on the measurement line above the softkeys on the display).

- 1 Press the **Quick Meas** key to display the automatic measurement menu.
- 2 Press the **Source** softkey to select the channel or running math function on which the quick measurements will be made.

Only channels or math functions that are displayed are available for measurements. If you choose an invalid source channel for a measurement, the measurement will default to the nearest in the list that makes the source valid.

If a portion of the waveform required for a measurement is not displayed or does not display enough resolution to make the measurement, the result will be displayed with a message such as greater than a value, less than a value, not enough edges, not enough amplitude, incomplete, or waveform is clipped to indicate that the measurement may not be reliable.

- 3 Press the **Clear Meas** softkey to stop making measurements and to erase the measurement results from the measurement line above the softkeys.

When **Quick Meas** is pressed again, the default measurements on an analog channel will be will be Frequency and Peak-Peak.

- 4 Choose what measurement you want on that source by pressing the **Select** softkey, then turn the Entry knob  to select the desired measurement from the popup list.
- 5 Press the **Measure** softkey to make the selected measurement.
- 6 To turn off **Quick Meas**, press the **Quick Meas** key again until it is not illuminated.

For detailed information about making automatic measurements, refer to the “Making Measurements” chapter.

To modify the display grid

- 1 Press the **Display** key.
- 2 Turn the Entry knob to change the intensity of the displayed grid. The intensity level is shown in the **Grid** softkey and is adjustable from 0 to 100%.

Each major division in the grid (also known as graticule) corresponds to the sweep speed time shown in the status line on the top of the display.

- To change waveform intensity, turn the **INTENSITY** knob on the lower-left corner of the front panel.

To print the display

You can print the complete display, including the status line and softkeys, to a parallel printer or to the floppy disk by pressing the **Quick Print** key. You can stop printing by pressing the **Cancel Print** softkey.

To set up your printer, press the **Utility** key, then press the **Print Config** softkey.

For more information on printing and floppy disk operation, refer to the “Utilities” chapter.

Triggering the Oscilloscope

The Agilent 54620/40-series Oscilloscopes provide a full set of features to help automate your measurement tasks, including MegaZoom technology to help you capture and examine the stored waveforms of interest, even untriggered waveforms. With these oscilloscopes you can:

- modify the way the oscilloscope acquires data.
- set up simple or complex trigger conditions, as needed, to capture only the sequence of events you want to examine.

The oscilloscopes all have common triggering functionality:

- Trigger modes
 - Auto
 - Normal
 - Auto Level (54620-series only)
- Coupling (including high frequency and noise rejection)
- Holdoff
- Trigger Level
- External Trigger input
- Trigger types
 - Edge (slope)
 - Pulse width (glitch)
 - Pattern
 - CAN
 - Duration
 - I²C
 - LIN
 - Sequence
 - SPI
 - TV
 - USB
- Trigger Out connector

Selecting Trigger Modes and Conditions

The trigger mode affects the way in which the oscilloscope searches for the trigger. The figure below shows the conceptual representation of acquisition memory. Think of the trigger event as dividing acquisition memory into a pre-trigger and post-trigger buffer. The position of the trigger event in acquisition memory is defined by the time reference point and the delay setting.

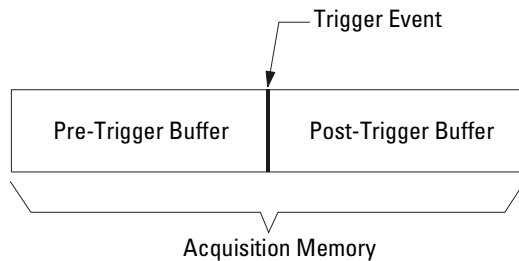

Acquisition Memory

To select the Mode and Coupling menu

- Press the **Mode/Coupling** key in the Trigger section of the front panel.

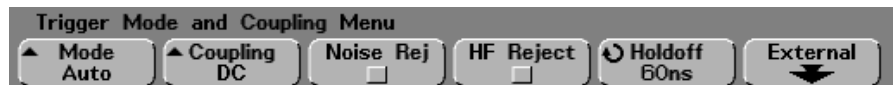

To select a trigger mode: Normal, Auto, Auto Level

- 1 Press the **Mode/Coupling** key.
- 2 Press the **Mode** softkey, then select **Normal**, **Auto**, or **Auto Level** mode.
 - **Normal** mode displays a waveform when the trigger conditions are met, otherwise the oscilloscope does not trigger and the display is not updated.
 - **Auto** mode is the same as Normal mode, except it forces the oscilloscope to trigger if the trigger conditions are not met.
 - **Auto Level** mode (54620-series only) works only when edge triggering on analog channels or external trigger. The oscilloscope first tries to Normal trigger. If no trigger is found, it searches for a signal at least 10% of full scale on the trigger source and sets the trigger level to the 50% amplitude point. If there is still no signal present, the oscilloscope auto triggers. This mode is useful when moving a probe from point to point on a circuit board.

Auto Level and Auto modes

Use the auto trigger modes for signals other than low-repetitive-rate signals and for unknown signal levels. To display a dc signal, you must use one of these two auto trigger modes since there are no edges on which to trigger.

Auto Level mode (54620-series only) is the same as Auto mode with an automatic trigger level adjustment. The oscilloscope looks at the level on the signals, and if the trigger level is out-of-range with respect to the signal, the scope adjusts the trigger level back to the middle of the signal.

When you select **Run**, the oscilloscope operates by first filling the pre-trigger buffer. It starts searching for a trigger after the pre-trigger buffer is filled, and continues to flow data through this buffer while it searches for the trigger. While searching for the trigger, the oscilloscope overflows the pre-trigger buffer; the first data put into the buffer is the first pushed out (FIFO). When a trigger is found, the pre-trigger buffer will contain the events that occurred just before the trigger. If no trigger is found, the oscilloscope generates a trigger and displays the data as though a trigger had occurred.

When you select **Single**, the oscilloscope will fill pre-trigger buffer memory, and continue flowing data through the pre-trigger buffer until the auto trigger overrides the searching and forces a trigger. At the end of the trace, the scope will stop and display the results.

Normal mode

Use Normal trigger mode for low repetitive-rate signals or when Auto trigger is not required. In this mode, the oscilloscope has the same behavior whether the acquisition was initiated by pressing **Run/Stop** or **Single**.

In Normal mode the oscilloscope must fill the pre-trigger buffer with data before it will begin searching for a trigger event. The trigger mode indicator on the status line flashes to indicate the oscilloscope is filling the pre-trigger buffer. While searching for the trigger, the oscilloscope overflows the pre-trigger buffer; the first data put into the buffer is the first pushed out (FIFO).

When the trigger event is found, the oscilloscope will fill the post-trigger buffer and display the acquisition memory. If the acquisition was initiated by **Run/Stop**, the process repeats. The waveform data will be scrolled onto the display as it is being acquired.

In either Auto or Normal mode, the trigger may be missed completely under certain conditions. This is because the oscilloscope will not recognize a trigger event until the pre-trigger buffer is full. Suppose you set the Time/Div knob to a slow sweep speed, such as 500 ms/div. If the trigger condition occurs before the oscilloscope has filled the pre-trigger buffer, the trigger will not be found. If you use Normal mode and wait for the trigger condition indicator to flash before causing the action in the circuit, the oscilloscope will always find the trigger condition correctly.

Some measurements you want to make will require you to take some action in the circuit under test to cause the trigger event. Usually, these are single-shot acquisitions, where you will use the **Single** key.

To select trigger Coupling

- 1 Press the **Mode/Coupling** key.
- 2 Press the **Coupling** softkey, then select **DC**, **AC**, or **LF Reject** coupling.
 - **DC** coupling allows dc and ac signals into the trigger path.
 - **AC** coupling places a high-pass filter (3.5 Hz for 54620-series analog channels, 10 Hz for 54640-series analog channels, and 3.5 Hz for all External trigger inputs) in the trigger path removing any DC offset voltage from the trigger waveform. Use AC coupling to get a stable edge trigger when your waveform has a large DC offset.
 - **LF** (low frequency) **Reject** coupling places a 50-kHz high-pass filter in series with the trigger waveform. Low frequency reject removes any unwanted low frequency components from a trigger waveform, such as power line frequencies, that can interfere with proper triggering. Use this coupling to get a stable edge trigger when your waveform has low frequency noise.
 - **TV** coupling is normally grayed-out, but is automatically selected when TV trigger is enabled in the Trigger More menu.

To select Noise Reject and HF Reject

- 1 Press the **Mode/Coupling** key.
- 2 Press the **Noise Rej** softkey to select noise reject or press the **HF Reject** softkey to select high frequency reject.
 - **Noise Rej** adds additional hysteresis to the trigger circuitry. When noise reject is on, the trigger circuitry is less sensitive to noise but may require a greater amplitude waveform to trigger the oscilloscope.
 - **HF Reject** adds a 50 kHz low-pass filter in the trigger path to remove high frequency components from the trigger waveform. You can use HF Reject to remove high-frequency noise, such as AM or FM broadcast stations or from fast system clocks, from the trigger path.

To set holdoff

- 1 Press the **Mode/Coupling** key.
- 2 Turn the Entry knob  to increase or decrease the trigger holdoff time shown in the **Holdoff** softkey.

Holdoff sets the amount of time that the oscilloscope waits before re-arming the trigger circuitry. Use Holdoff to stabilize the display of complex waveforms.

To get a stable trigger on the pulse burst shown below, set the holdoff time to be >200 ns but <600 ns.

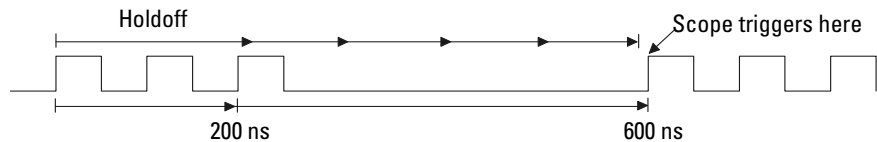

By setting the Holdoff, you can synchronize triggers. The oscilloscope will trigger on one edge of the waveform, and ignore further edges until the holdoff time expires. The oscilloscope will then re-arm the trigger circuit to search for the next edge trigger. This allows the oscilloscope to trigger on a repeating pattern in a waveform.

To set holdoff

Holdoff Operating Hints

Holdoff keeps a trigger from occurring until after a certain amount of time has passed since the last trigger. This feature is valuable when a waveform crosses the trigger level multiple times during one period of the waveform.

Without holdoff, the scope could trigger on each of the crossings, producing a confusing waveform. With holdoff set correctly, the scope always triggers on the same crossing. The correct holdoff setting is typically slightly less than one period. Set the holdoff to this time to generate a unique trigger point. This action works even though many waveform periods pass between triggers, because the holdoff circuit operates on the input signal continuously.

Changing the time base settings does not affect the holdoff number. In contrast, the holdoff in analog oscilloscopes is a function of the time base setting, making it necessary to re-adjust the holdoff each time you change the time base setting.

With Agilent's MegaZoom technology, you can press **Stop**, then pan and zoom through the data to find where it repeats. Measure this time using the cursors, then set holdoff to this number.

External Trigger Input

External Trigger can be used as a source in several of the trigger types. On 4-channel and mixed-signal oscilloscopes, the external trigger BNC input is on the rear panel and is labeled **Ext Trig**. On 2-channel oscilloscopes, the external trigger BNC input is on the front panel and is labeled **Ext Trigger**.



Maximum input voltage for the external trigger input:

CAT I 300 Vrms, 400 Vpk

CAT II 100 Vrms, 400 Vpk

with 10073C or 10074C 10:1 probe: CAT I 500 Vpk, CAT II 400 Vpk

CAUTION



Do not exceed 5 Vrms in 50Ω mode on the 54640-series models. Input protection is enabled in 50Ω mode and the 50Ω load will disconnect if greater than 5 Vrms is detected. However the input could still be damaged, depending on the time constant of the signal.

CAUTION

The 50Ω input protection mode on the 54640-series models only functions when the oscilloscope is powered on.

External Trigger Probe Settings

You can set probe attenuation, units, and input impedance for the external trigger input.

- 1 Press the **Mode/Coupling** key in the Trigger section of the front panel.

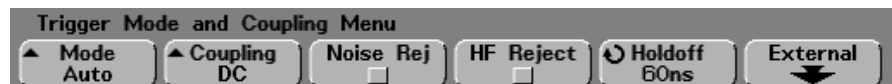

External Trigger Input

2 Press the **External** softkey to display the external trigger probe menu.

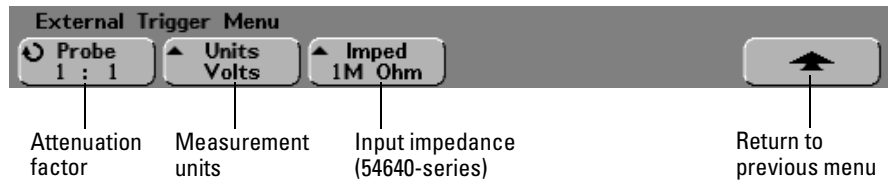

Probe Attenuation Turn the Entry knob to set the attenuation factor displayed in the **Probe** softkey for the connected probe. The attenuation factor can be set from 0.1:1 to 1000:1 in a 1-2-5 sequence.

For 2-channel oscilloscopes that have the Ext Trigger connector on the front panel, when you connect an AutoProbe self-sensing probe, the oscilloscope will automatically configure your probe to the correct attenuation factor.

The probe correction factor must be set properly for measurements to be made correctly.

Probe Units Press the **Units** softkey to select the proper measurement unit for the connected probe. Select **Volts** for a voltage probe and select **Amps** for a current probe. Measurement results, channel sensitivity, and trigger level will reflect the measurement units you have selected.

Input Impedance The 54620-series oscilloscope external trigger input impedance is always 1 M Ω . The 54640-series oscilloscope external trigger input impedance can be set to either **1M Ohm** or **50 Ohm** by pressing the **Imped** softkey.

- **50 Ohm** mode matches 50-ohm cables commonly used in making high frequency measurements. This impedance matching gives you the most accurate measurements since reflections are minimized along the signal path.
- **1M Ohm** mode is for use with probes and for general-purpose measurements. The higher impedance minimizes the loading effect of the oscilloscope on the circuit under test.

For 2-channel oscilloscopes that have the Ext Trigger connector on the front panel, when you connect an AutoProbe self-sensing probe, the oscilloscope will automatically configure your probe to the correct impedance.

Trigger Types

The oscilloscope allows you to synchronize the display to the actions of the circuit under test by defining a trigger condition. You can use any input channel or the Ext Trigger BNC for the source for most trigger types.

MegaZoom Technology Simplifies Triggering

With the built-in MegaZoom technology, you can simply Autoscale the waveforms, then stop the scope to capture a waveform. You can then pan and zoom through the data using the Horizontal and Vertical knobs to find a stable trigger point. Autoscale often produces a triggered display.

These trigger types are available and are presented in the following order in this chapter:

- Edge trigger
- Pulse Width (glitch) trigger
- Pattern trigger
- CAN (Controller Area Network) trigger
- Duration trigger
- I²C (Inter-IC bus) trigger
- LIN (Local Interconnect Network)
- Sequence trigger
- SPI (Serial Peripheral Interface) trigger
- TV trigger
- USB (Universal Serial Bus) trigger

Changes to the trigger specification are applied when you make them. If the oscilloscope is stopped when you change a trigger specification, the scope will use the new specification when you press **Run/Stop** or **Single**. If the oscilloscope is running when you change a triggering specification, it uses the new trigger definition when it starts the next acquisition. You select the trigger type by pressing the key associated with the desired trigger type.

To use Edge triggering

The Edge trigger type identifies a trigger by looking for a specified slope and voltage level on a waveform. You can define the trigger source and rising or falling edge in this menu. The trigger type, source, and level is displayed in the upper-right corner of the display.

- 1 Press the **Edge** key in the Trigger section of the front panel to display the Edge trigger menu.

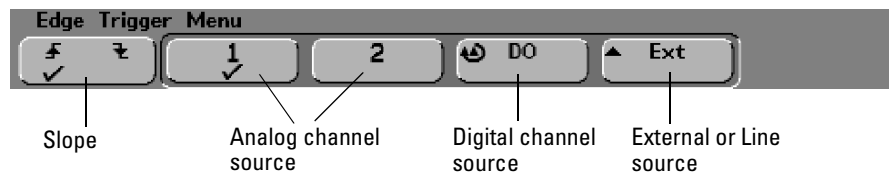
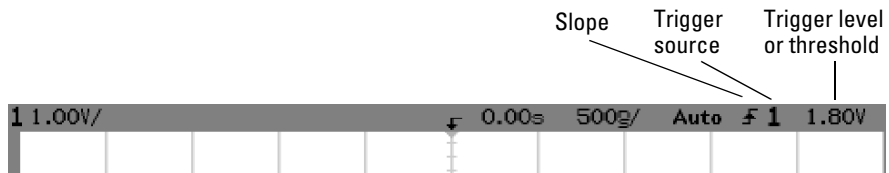

- 2 Press the slope softkey (⌆ ⌵) and select either rising edge or falling edge. This determines whether the trigger will occur on the rising edge or the falling edge of the input signal.

Slope Selects rising edge (⌆) or falling edge (⌵) for the selected trigger source. The selected slope is displayed in the upper-right corner of the display.

- 3 Select 1, 2, Ext, or Line as the trigger source.

The trigger source can also be set to channel 3 and 4 on the 4-channel oscilloscope, or can be set to digital channels D15 through D0 on the mixed-signal oscilloscope. You can choose a channel that is turned off as the source for the edge trigger. The selected trigger source is displayed in the upper-right corner of the display next to the slope symbol:

1 through 4 = analog channels

D15 through D0 = digital channels

E = External trigger

L = Line trigger

Analog source Press the analog channel source softkey to select an analog source. Adjust the trigger level for the selected analog channel by turning the Trigger Level knob. The position of the trigger level for the analog channel is indicated by the trigger level icon **T** (if the analog channel is on) at the far left side of the display when DC coupling is selected. The value of the analog channel trigger level is displayed in the upper-right corner of the display.

Digital source (mixed-signal oscilloscope) Press the digital source softkey or turn the Entry knob to select a digital channel (D15-D0) as the trigger source. Select **Threshold** in the **D7 Thru D0** or **D15 Thru D8** menu to set the threshold level (TTL, CMOS, ECL, or user defined) for the selected digital channel group. The threshold value is displayed in the upper-right corner of the display.

External/Line source **Ext** (external trigger) and **Line** (triggers off the power line frequency) trigger share the same softkey on the display. Toggle the softkey to select the source you want.

The external trigger input is on the front panel of the 2-channel oscilloscope and on the rear-panel of 4-channel and mixed-signal oscilloscope. You can connect the trigger output of other instruments to this external trigger input, or use an oscilloscope probe, such as the 10073C or 10074C.

Adjust the external trigger level for the selected analog channel by turning the Trigger Level knob. The trigger level for **Line** is not adjustable.

To use Pulse Width triggering

Pulse Width (glitch) triggering sets the oscilloscope to trigger on a positive pulse or a negative pulse of a specified width. If you want to trigger on a specific timeout value, use **Duration** trigger in the trigger **More** menu.

- 1 Press the **Pulse Width** key in the Trigger section of the front panel to display the Pulse Width trigger menu.

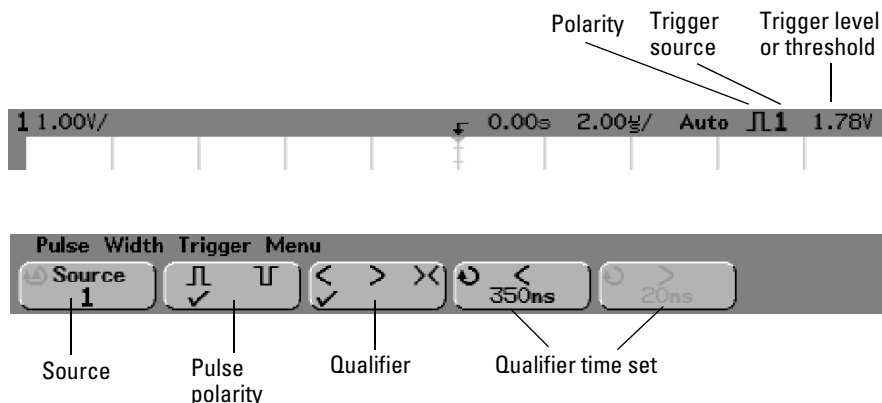

- 2 Press the **Source** softkey (or rotate the Entry knob on mixed-signal oscilloscopes) to select a channel source for the trigger.

The channel you select is shown in the upper-right corner of the display next to the polarity symbol.

The source can be any analog or digital channel available on your oscilloscope. External trigger may also be specified as a source when using the 2-channel and 4-channel oscilloscopes.

Adjust the trigger level for the selected analog channel source by turning the Trigger **Level** knob. The position of the trigger level for the analog channel is indicated by the trigger level icon **T** (if the analog channel is on) at the far left side of the display when DC coupling is selected. Set the threshold for the selected digital channel group by pressing the **D7 Thru D0** or **D15 Thru D8** key then press the **Threshold** softkey. The value of the trigger level or digital threshold is displayed in the upper-right corner of the display.

3 Press the pulse polarity softkey to select positive (\uparrow) or negative (\downarrow) polarity for the pulse width you want to capture.

The selected pulse polarity is displayed in the upper-right corner of the display. A positive pulse is higher than the current trigger level or threshold and a negative pulse is lower than the current trigger level or threshold.

When triggering on a positive pulse, the trigger will occur on the high to low transition of the pulse if the qualifying condition is true. When triggering on a negative pulse, the trigger will occur on the low to high transition of the pulse if the qualifying condition is true.

4 Press the qualifier softkey ($<$ $>$ $><$) to select the time qualifier.

The Qualifier softkey can set the oscilloscope to trigger on a pulse width that is:

- less than a time value ($<$).

For example, for a positive pulse, if you set $t < 10$ ns:



- greater than a time value ($>$).

For example, for a positive pulse, if you set $t > 10$ ns:



- within a range of time values ($><$).

For example, for a positive pulse, if you set $t > 10$ ns and $t < 15$ ns:

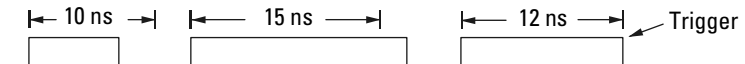

Triggering the Oscilloscope
To use Pulse Width triggering

- 5 Select the qualifier time set softkey (< or >), then rotate the Entry knob to set the pulse width qualifier time.

The qualifiers can be set as follows:

54620-series <ul style="list-style-type: none">• 5 ns to 10 for > or < qualifier• 10 ns to 10 s for >< qualifier, with minimum difference of 5 ns between upper and lower settings
54640-series <ul style="list-style-type: none">• 2 ns to 10 s for > or < qualifier when source is analog channel or external trigger• 5 ns to 10 s for > or < qualifier when source is digital channel• 10 ns to 10 s for >< qualifier , with minimum difference of 5 ns between upper and lower settings.

< qualifier time set softkey

- When the less than (<) qualifier is selected, the Entry knob sets the oscilloscope to trigger on a pulse width less than the time value displayed on the softkey.
- When the time range (><) qualifier is selected, the Entry knob sets the upper time range value.

> qualifier time set softkey

- When the greater than (>) qualifier is selected, the Entry knob sets the oscilloscope to trigger on a pulse width greater than the time value displayed on the softkey.
- When the time range (><) qualifier is selected, the Entry knob sets the lower time range value.

To use Pattern triggering

The Pattern trigger identifies a trigger condition by looking for a specified pattern. This pattern is a logical AND combination of the channels. Each channel can have a value of high (H), low (L), don't care (X). A rising or falling edge can be specified for one channel included in the pattern.

- 1 Press the **Pattern** key in the Trigger section of the front panel to display the Pattern trigger menu.

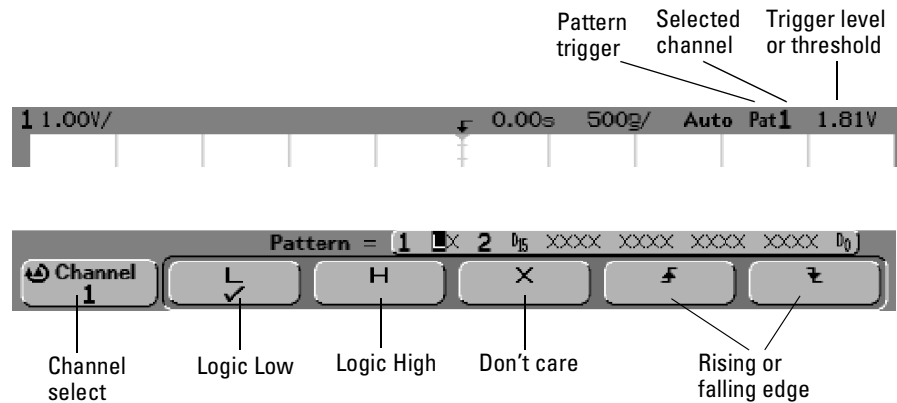



- 2 For each analog or digital channel you want to include in the desired pattern, press the **Channel** softkey to select the channel.

This is the channel source for the H, L, X, or edge condition. As you press the **Channel** softkey (or rotate the Entry knob on mixed-signal oscilloscopes), the channel you select is highlighted in the **Pattern =** line directly above the softkeys and in the upper-right corner of the display next to "Pat". External trigger may also be specified as a channel in the pattern when using the 2-channel and 4-channel oscilloscopes.

Adjust the trigger level for the selected analog channel by turning the **Trigger Level** knob. The position of the trigger level for the analog channel is indicated by the trigger level icon **T** at the far left side of the display when DC coupling is selected. Set the threshold for the selected digital channel group by pressing the **D7 Thru D0** or **D15 Thru D8** key then press the **Threshold** softkey. The value of the trigger level or digital threshold is displayed in the upper-right corner of the display.

To use Pattern triggering

- 3 For each channel you select, press one of the condition softkeys to set the condition for that channel in the pattern.
- **H** sets the pattern to high on the selected channel. A high is a voltage level that is greater than the channel's trigger level or threshold level.
 - **L** sets the pattern to low on the selected channel. A low is a voltage level that is less than the channel's trigger level or threshold level.
 - **X** sets the pattern to don't care on the selected channel. Any channel set to don't care is ignored and is not used as part of the pattern. If all channels in the pattern are set to don't care, the oscilloscope will not trigger.
 - The rising edge () or falling edge () falling edge softkey sets the pattern to an edge on the selected channel. Only one rising or falling edge can be specified in the pattern. When an edge is specified, the oscilloscope will trigger at the edge specified if the pattern set for the other channels is true. If no edge is specified, the oscilloscope will trigger on the last edge that makes the pattern true.

Specifying an Edge in a Pattern

You are allowed to specify only one rising or falling edge term in the pattern. If you define an edge term, then select a different channel in the pattern and define another edge term, the previous edge definition is changed to a don't care.

To use CAN triggering

Agilent N2758A CAN Trigger Module

The following topic discusses the basic CAN triggering available in the 54620/40-series oscilloscopes. For advanced CAN triggering using the optional Agilent N2758A CAN Trigger Module for 54620/40-series Mixed-signal oscilloscopes, refer to the N2758A User's Guide

Controller Area Network (CAN) trigger will trigger on CAN version 2.0A and 2.0B signals. Setup consists of connecting the oscilloscope to a CAN signal. Press the **Settings** softkey to specify baud rate, signal source, and signal type to trigger on.

The CAN trigger will trigger on the Start of Frame (SOF) bit of a Data frame, Remote Transfer Request (RTR) frame, or an Overload frame. A CAN message frame in CAN_L signal type is shown below:

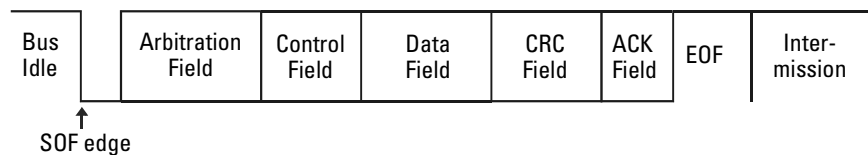

- 1 Press the **More** key in the Trigger section of the front panel, rotate the Entry knob until **CAN** is displayed in the **Trigger** softkey, then press the **Settings** softkey to display CAN trigger menu.

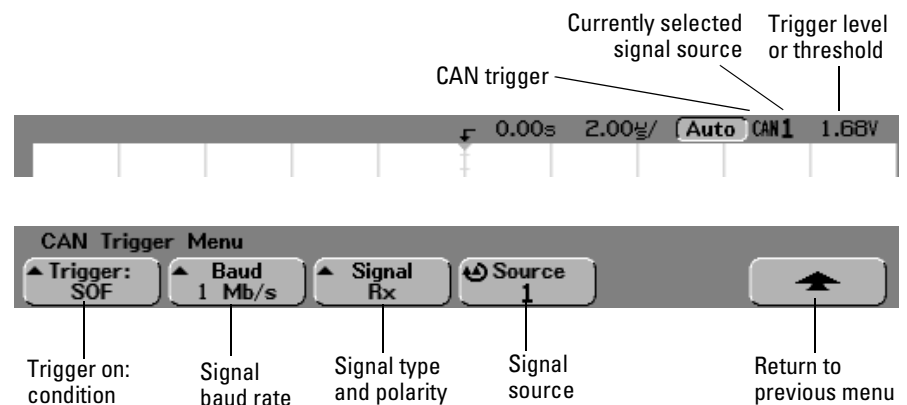

To use CAN triggering

- 2 Press the **Baud** softkey to set the CAN signal baud rate to match your CAN bus signal.

The CAN baud rate can be set to:

10 kb/s	50 kb/s	100 kb/s	500 kb/s
20 kb/s	62.5 kb/s	125 kb/s	800 kb/s
33.3 kb/s	83.3 kb/s	250 kb/s	1 Mb/s

The default baud rate is 1 Mb/s

- 3 Press the **Trigger:** softkey to select the trigger condition.

The **SOF** (Start of Frame) is the only trigger condition available. The CAN trigger will trigger on the Start of Frame bit of a Data frame, Remote Transfer Request (RTR) frame, or an Overload frame.

- 4 Press the **Signal** softkey to set the type and polarity of the CAN signal.

This also automatically sets the channel label for the source channel. The channel shown in the **Source** softkey can be connected as follows:

Dominant high signal:

- **CAN_H** - the actual CAN_H differential bus signal.

Dominant low signals:

- **CAN_L** - the actual CAN_L differential bus signal.
- **Rx** - the Receive signal from the CAN bus transceiver.
- **Tx** - the Transmit signal to the CAN bus transceiver.
- **Differential** - the CAN differential bus signals connected to an analog source channel using a differential probe.

- 5 Press the **Source** softkey to select the channel connected to the CAN signal line.

If the Signal softkey is set to Differential, connect an analog source channel to the CAN differential bus signal using a differential probe.

As you press the **Source** softkey (or rotate the Entry knob on mixed-signal oscilloscopes), the **CAN** label for the source channel is automatically set and the channel you select is shown in the upper-right corner of the display next to "**CAN**".

Adjust the trigger level for the selected analog channel by turning the Trigger Level knob. Select **Threshold** in the **D7 Thru D0** or **D15 Thru D8** menu to set the level for digital channels. The value of the trigger level or digital threshold is displayed in the upper-right corner of the display.

To use Duration triggering

Duration trigger lets you define a pattern, then trigger on a specified time duration of this logical AND combination of the channels.

- 1 Press the **More** key in the Trigger section of the front panel, rotate the Entry knob until **Duration** is displayed in the **Trigger** softkey, then press the **Settings** softkey to display the Duration trigger menu.

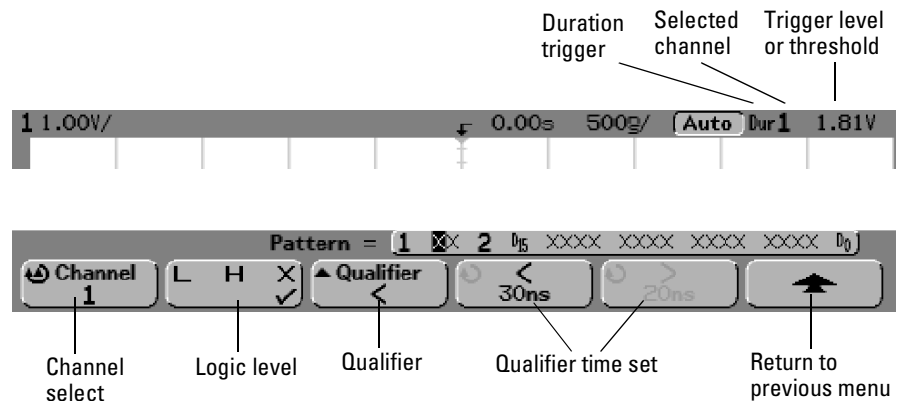

- 2 For each analog or digital channel you want to include in the desired pattern, press the **Channel** softkey to select the channel.

This is the channel source for the H, L, or X condition. As you press the **Channel** softkey (or rotate the Entry knob on mixed-signal oscilloscopes), the channel you select is highlighted in the **Pattern =** line directly above the softkeys and in the upper-right corner of the display next to "**Dur**". External trigger may also be specified as a channel in the pattern when using the 2-channel and 4-channel oscilloscopes.

Adjust the trigger level for the selected analog channel by turning the **Trigger Level** knob. The position of the trigger level for the analog channel is indicated by the trigger level icon **T** at the far left side of the display when DC coupling is selected. Set the threshold for the selected digital channel group by pressing the **D7 Thru D0** or **D15 Thru D8** key then press the **Threshold** softkey. The value of the trigger level or digital threshold is displayed in the upper-right corner of the display.

To use Duration triggering

3 For each channel you select, press the logic level softkey to set the condition for that channel in the pattern.

- **H** sets the pattern to high on the selected channel. A high is a voltage level that is greater than the channel's trigger level or threshold level.
- **L** sets the pattern to low on the selected channel. A low is a voltage level that is less than the channel's trigger level or threshold level.
- **X** sets the pattern to don't care on the selected channel. Any channel set to don't care is ignored and is not used as part of the pattern. If all channels in the pattern are set to don't care, the oscilloscope will not trigger.

4 Press the **Qualifier** softkey to set the time duration qualifier for the pattern.

The time qualifier can set the oscilloscope to trigger on a channel pattern whose time duration is:

- less than a time value (<)
- greater than a time value (>)
- greater than a time value, but with timeout (**Timeout**). A trigger will be forced at the timeout value, rather than occurring when the pattern is exited.
- within a range of time values (><)
- outside a range of time values (<>)

The time values for the selected qualifier are set using the qualifier time set softkeys (< and >) and the Entry knob.

- 5 Select a qualifier time set softkey (< or >), then rotate the Entry knob to set the duration qualifier time.

< qualifier time set softkey

- When the less than (<) qualifier is selected, the Entry knob sets the oscilloscope to trigger on a pattern duration less than the time value displayed on the softkey.
- When the within time range (><) qualifier is selected, the Entry knob sets the upper time range value.
- When the out of time range (<>) qualifier is selected, the Entry knob sets the lower time range value.

> qualifier time set softkey

- When the greater than (>) qualifier is selected, the Entry knob sets the oscilloscope to trigger on a pattern duration greater than the time value displayed on the softkey.
- When the within time range (><) qualifier is selected, the Entry knob sets the lower time range value.
- When the out of time range (<>) qualifier is selected, the Entry knob sets the upper time range value.
- When **Timeout** qualifier is selected, the Entry knob sets the timeout value.

When the duration trigger occurs

The timer starts on the last edge that makes the pattern (logical AND) true. The trigger will occur on the first edge that makes the pattern false if the time qualifier criteria of the pattern has been met, except in Timeout mode. In Timeout, the trigger occurs when the timeout value is reached while the pattern is true.

To use I²C triggering

An I²C (Inter-IC bus) trigger setup consists of connecting the oscilloscope to the serial data (SDA) line and the serial clock (SCL) line, then triggering on a stop/start condition, a restart, a missing acknowledge, an EEPROM data read, or on a read/write frame with a specific device address and data value.

- 1 Press the **More** key in the Trigger section of the front panel, rotate the Entry knob until **I²C** is displayed in the **Trigger** softkey, then press the **Settings** softkey to display the I²C trigger menu.

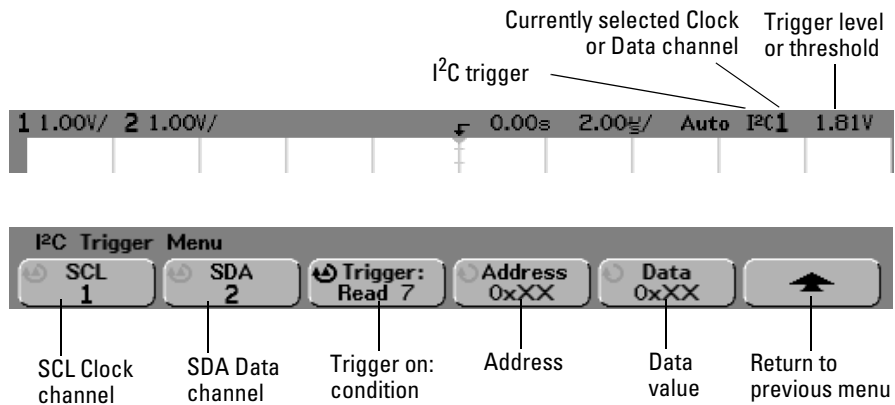

- 2 Connect an oscilloscope channel to the SCL (serial clock) line in the circuit under test, then set the **SCL** clock channel softkey to that channel.

As you press the **SCL** softkey (or rotate the Entry knob on mixed-signal oscilloscopes), the **SCL** label for the source channel is automatically set and the channel you select is shown in the upper-right corner of the display next to "I²C".

Adjust the trigger level for the selected analog channel by turning the Trigger **Level** knob. For the mixed-signal oscilloscope, select **Threshold** in the **D7 Thru D0** or **D15 Thru D8** menu to set the level for digital channels assigned to the clock and data lines. The value of the trigger level or digital threshold is displayed in the upper-right corner of the display.

- 3 Connect an oscilloscope channel to the SDA (serial data) line in the circuit under test, then set the **SDA** data channel softkey to that channel.

As you press the **SDA** softkey (or rotate the Entry knob on mixed-signal oscilloscopes), the **SDA** label for the source channel is automatically set and the channel you select is shown in the upper-right corner of the display next to "I²C".

Adjust the trigger level for the selected analog channel by turning the Trigger **Level** knob. For the mixed-signal oscilloscope, select **Threshold** in the **D7 Thru D0** or **D15 Thru D8** menu to set the level for digital channels assigned to the clock and data lines. The value of the trigger level or digital threshold is displayed in the upper-right corner of the display.

Data needs to be stable during the whole high clock cycle or it will be interpreted as a start or stop condition (data transitioning while the clock is high).

- 4 Press the **Trigger:** softkey to select one of the following I²C trigger conditions:

Start Condition: the oscilloscope triggers when SDA data transitions from high to low while the SCL clock is high. For triggering purposes (including frame triggers), a restart is treated as a start condition.

Stop Condition: the oscilloscope triggers when data (SDA) transitions from low to high while the clock (SCL) is high.

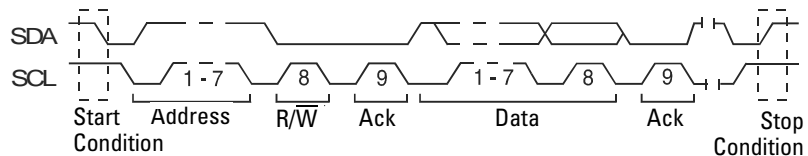

Missing Acknowledge: the oscilloscope triggers when SDA data is high during any Ack SCL clock bit.

Restart: the oscilloscope triggers when another start condition occurs before a stop condition.

Triggering the Oscilloscope

To use I2C triggering

EEPROM Data Read: the trigger looks for EEPROM control byte value 1010xxx on the SDA line, followed by a Read bit and an Ack bit. It then looks for the data value and qualifier set by the **Data** softkey and the **Data is** softkey. When this event occurs, the scope will trigger on the clock edge for the Ack bit after the data byte. This data byte does not need to occur directly after the control byte.

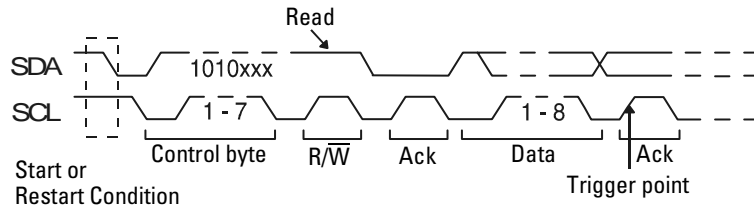

Frame (Start: Addr7: Read: Ack: Data) or

Frame (Start: Addr7: Write: Ack: Data): the oscilloscope triggers on a read or write frame in 7-bit addressing mode on the 17th clock edge if all bits in the pattern match. For triggering purposes, a restart is treated as a start condition.

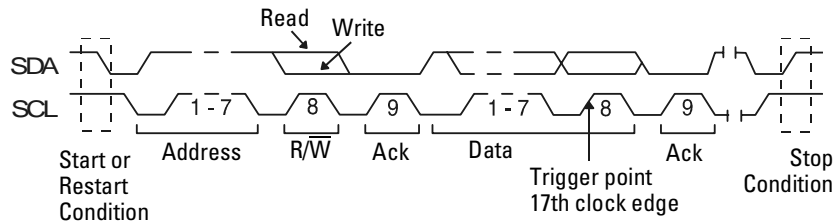

10-bit Write: the oscilloscope triggers on a 10-bit write frame on the 26th clock edge if all bits in the pattern match. The frame is in the format:

Frame (Start: Address byte 1: Write: Address byte 2: Ack: Data)

For triggering purposes, a restart is treated as a start condition.

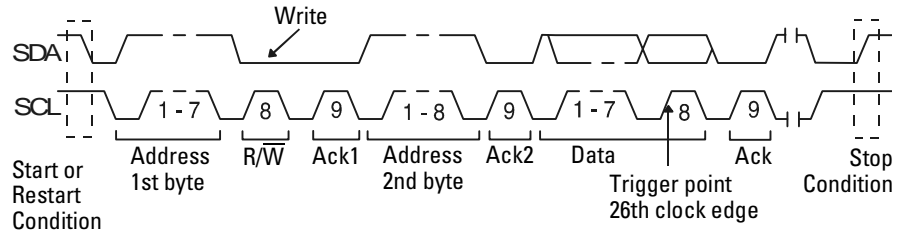

5 If you have set the oscilloscope to trigger on an EEPROM Data Read condition:

Press the **Data is** softkey to set the oscilloscope to trigger when data is = (equal to), \neq (not equal to), < (less than), or > (greater than) the data value set in the **Data** softkey.

The oscilloscope will trigger on the clock edge for the Ack bit after the trigger event is found. This data byte does not need to occur directly after the control byte. The oscilloscope will trigger on any data byte that meets the criteria defined by the **Data is** and **Data** softkeys during a current address read or a random read or a sequential read cycle.

To use I2C triggering

6 If you have set the oscilloscope to trigger on a 7-bit address read or write frame condition or a 10-bit write frame condition:

- a Press the **Address** softkey and turn the Entry knob to select the 7-bit or 10-bit device address.

You can select from an address range of 0x00 to 0x7F (7-bit) or 0x3FF (10-bit) hexadecimal. When triggering on a read/write frame, the oscilloscope will trigger after the start, address, read/write, acknowledge, and data events occur.

If don't care is selected (0xXX or 0xXXX) for the address, the address will be ignored. The trigger will always occur on the 17th clock for 7-bit addressing or 26th clock for 10-bit addressing.

- b Press the **Data value** softkey and turn the Entry knob to select the 8-bit data pattern on which to trigger.

You can select a data value in the range of 0x00 to 0xFF (hexadecimal). The oscilloscope will trigger after the start, address, read/write, acknowledge, and data events occur.

If don't care (0xXX) is selected for data, the data will be ignored. The trigger will always occur on the 17th clock for 7-bit addressing or 26th clock for 10-bit addressing.

To use LIN triggering

LIN (Local Interconnect Network) trigger setup consists of connecting the oscilloscope to a serial LIN signal.

The LIN trigger will trigger on the rising edge at the Sync Break exit of the LIN single-wire bus signal that marks the beginning of the message frame. A LIN signal message frame is shown below:

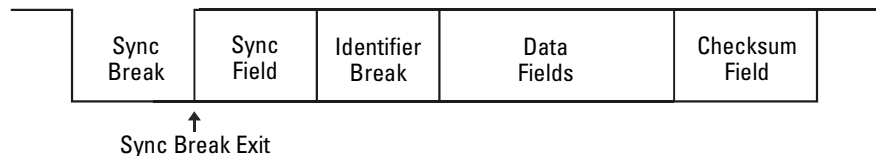

- 1 Press the **More** key in the Trigger section of the front panel, rotate the Entry knob until **LIN** is displayed in the **Trigger** softkey, then press the **Settings** softkey to display LIN trigger menu.

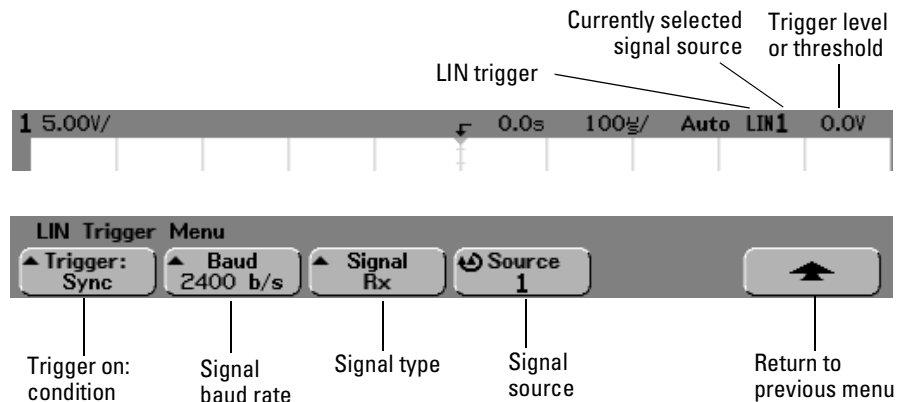

- 2 Press the **Baud** softkey to set the LIN signal baud rate to match your LIN bus signal.

The LIN baud rate can be set to 2400 b/s, 9600 b/s, or 19.2 kb/s. The default baud rate is 2400 b/s.

To use LIN triggering

3 Press the **Trigger:** softkey to select the trigger condition.

Sync (Sync Break) is the only trigger condition available. The LIN trigger will trigger on the rising edge at the Sync Break exit of the LIN single-wire bus signal that marks the beginning the message frame.

4 Press the **Signal** softkey to set the type of the LIN signal.

This also automatically sets the channel label for the source channel. The channel shown in the **Source** softkey can be connected to the dominant low signal as follows:

- **LIN** - the actual LIN single-end bus signal line.
- **Rx** - the Receive signal from the LIN bus transceiver.
- **Tx** - the Transmit signal to the LIN bus transceiver.

5 Press the **Source** softkey to select the channel connected to the LIN signal line.

As you press the **Source** softkey (or rotate the Entry knob on mixed-signal oscilloscopes), the **LIN** label for the source channel is automatically set and the channel you select is shown in the upper-right corner of the display next to "**LIN**".

Adjust the trigger level for the selected analog channel by turning the Trigger Level knob. Select **Threshold** in the **D7 Thru D0** or **D15 Thru D8** menu to set the level for digital channels. The value of the trigger level or digital threshold is displayed in the upper-right corner of the display.

To use Sequence triggering

Sequence trigger allows you to trigger the oscilloscope after finding a sequence of events. Defining a sequence trigger requires three steps:

a Define an event to find before you search for the trigger.

The “find” event can be a pattern, an edge from a single channel, or the combination of a pattern and a channel edge.

b Define the trigger event.

The “trigger on” event can be a pattern, an edge from a single channel, the combination of a pattern and a channel edge, or the nth occurrence of an edge from a single channel.

c Set an optional reset event.

If you choose to define a “reset” event, the event can be a pattern, an edge from a single channel, the combination of a pattern and a channel edge, or a timeout value.

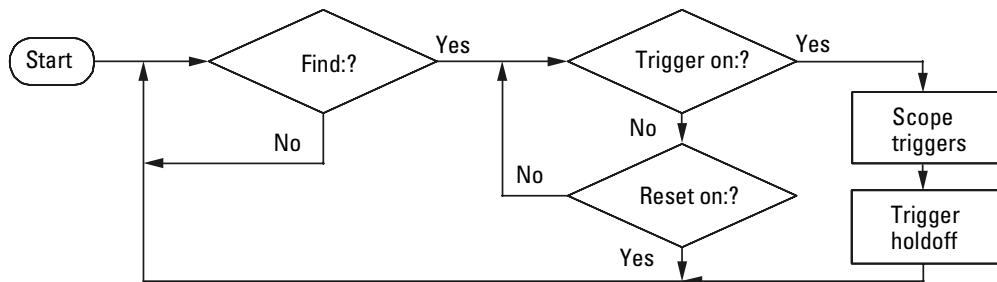

Sequence Trigger Flowchart

Triggering the Oscilloscope
To use Sequence triggering

- Press the **More** key in the Trigger section of the front panel, rotate the Entry knob until **Sequence** is displayed in the **Trigger** softkey, then press the **Settings** softkey to display Sequence trigger menu.

Annotations in the image:

- Sequence trigger**: Points to the top status bar area.
- Selected channel**: Points to the '1' in the 'Channel 1' button.
- Trigger level or threshold**: Points to the '1.81V' value in the top status bar.
- Sequence stage definitions**: Points to the 'First, find: Pattern 1 Entered' section.
- Term definitions**: Points to the table of definitions for P1, P2, E1, and E2.

Term	Channel	Level	Edge	Width	Mask	Mask	Mask	Mask	Mask	Mask
P1:	1	X	X	2	D ₁₅	XXXX	XXXX	XXXX	XXXX	D ₀
P2:	1	X	X	2	D ₁₅	XXXX	XXXX	XXXX	XXXX	D ₀
E1:	1	X	X	2	D ₁₅	XXXX	XXXX	XXXX	XXXX	D ₀
E2:	1	X	X	2	D ₁₅	XXXX	XXXX	XXXX	XXXX	D ₀

Sequence Trigger Menu buttons and their functions:

- Channel 1**: Channel select
- Stage Find**: Stage select
- Find: P1 Enter**: Find, Trigger on, or Reset condition
- Term Patrn 1**: Select term
- L H X**: Define term
- Return to previous menu**: Return to previous menu

As you set stage, term, and channel definitions for the sequence trigger, these settings will be shown in the waveform area of the display.

Define the Find: stage

1 Press the **Stage** softkey and select **Find**.

Find: is the first stage in the trigger sequence. When you select the **Stage Find** softkey, the next softkey to the right will display **Find:** and give you a list of the terms you can define for the Find stage. The Find stage can be set to one of the following conditions:

Pattern 1 Entered – A pattern is entered on the last edge that makes the pattern true (logical AND).

Pattern 1 Exited – A pattern is exited on the first edge that makes the pattern false (logical NAND).

Edge 1

Pattern 1 and Edge 1

2 Press the **Find:** softkey and select the Find stage condition.

3 To define the term(s) used in the Find stage, press the **Term** softkey and select the pattern and/or edge term displayed in the **Find:** softkey.

4 If you select a pattern term, each channel in the pattern must be set to a **H** (high), **L** (low), or **X** (don't care).

a Press the **Channel** softkey (or rotate the Entry knob on mixed-signal oscilloscopes) to select the channel.

As you select a channel, the channel is highlighted in the selected pattern list shown in the waveform area and is also shown in the upper-right corner of the display next to "**Seq**".

b Press the **L H X** softkey to set a level for the channel.

- **H** sets the pattern to high on the selected channel. A high is a voltage level that is greater than the channel's trigger level or threshold level.
- **L** sets the pattern to low on the selected channel. A low is a voltage level that is less than the channel's trigger level or threshold level.
- **X** sets the pattern to don't care on the selected channel. Any channel set to don't care is ignored and is not used as part of the pattern. If all channels in the pattern are set to don't care, the oscilloscope will not trigger.

Adjust the trigger level for the selected analog channel by turning the Trigger **Level** knob. Select **Threshold** in the **D7 Thru D0** or **D15 Thru D8** menu to set the level for the digital channel group. The value of the trigger level or digital threshold is displayed in the upper-right corner of the display.

c Repeat for all channels in the pattern.

Triggering the Oscilloscope

To use Sequence triggering

- 5 If you select an edge term, one channel must be set to a rising edge or a falling edge. All other channel edges will be set to don't care (X).
 - a Press the **Channel** softkey (or rotate the Entry knob on mixed-signal oscilloscopes) to select the channel.

As you select a channel, the channel is highlighted in the selected pattern list shown in the waveform area.
 - b Then press the **↕ ↙ X** softkey to select rising edge or falling edge. All other channels will be defaulted to don't care (X).

If you want to reassign an edge to a different channel, repeat the above step. The value of the original channel edge will be defaulted to **X** (don't care).

Define the Trigger on: stage

- 1 Press the **Stage** softkey and select **Trigger on:**.

Trigger on: is the next stage in the trigger sequence. When you select the **Stage Trigger on:** softkey, the next softkey to the right will display **Trigger:** and give you a list of the terms you can define for the Trigger on: stage. The Trigger on: stage can be set to one of the following conditions:

 - Pattern 2 Entered** – A pattern is entered on the last edge that makes the pattern true (logical AND).
 - Pattern 2 Exited** – A pattern is exited on the first edge that makes the pattern false (logical NAND).
 - Edge 2**
 - Pattern 2 and Edge 2**
 - Nth Edge 2**
- 2 Press the **Trigger:** softkey and select a stage to trigger on.
- 3 To define the term(s) used in the Trigger on: stage, press the **Term** softkey and select the pattern or edge term displayed in the **Trigger:** softkey.
- 4 If you select a pattern term, each channel in the pattern must be set to a **H** (high), **L** (low), or **X** (don't care).
 - a Press the **Channel** softkey (or rotate the Entry knob on mixed-signal oscilloscopes) to select the channel.
 - b Press the **L H X** softkey to set a level for the channel.
 - c Repeat for all channels in the pattern.

- 5 If you select an edge term, one channel must be set to a rising edge or a falling edge. All other channel edges will be set to don't care (X).
 - a Press the **Channel** softkey (or rotate the Entry knob on mixed-signal oscilloscopes) to select the channel.

The channel you select is shown in the upper-right corner of the display next to "Seq".
 - b Then press the **↕ ↘ X** softkey to select rising edge or falling edge. All other channel edges will be defaulted to don't care.
- 6 When you set a Trigger on: condition to trigger on Edge 2, you can also select which occurrence of Edge 2 to trigger on.
 - a Make sure **Nth Edge 2** is selected in the **Trigger:** softkey
 - b Press the **Term** softkey and select **Count (N)**.
 - c Press the **N** softkey, then turn the Entry knob to set the number of edges to wait before triggering.

If the Find event occurs again before the Count (N) event is satisfied, Count (N) will be reset to zero. **N** can be set from 1 to 10,000.

Define the optional Reset on: stage

- 1 Press the **Stage** softkey and select **Reset on:**.

Reset on: is the last stage in the trigger sequence. When you select the **Stage Reset on:** softkey, the next softkey to the right will display **Reset:** and give you a list of the terms you can define for the Reset on: stage. The Reset on: stage can be set to one of the following conditions:

No Reset - Resets on the find condition.

Pattern 1 (or 2) Entered - A pattern is entered on the last edge that makes the pattern true (logical AND).

Pattern 1 (or 2) Exited - A pattern is exited on the first edge that makes the pattern false (logic NAND).

Edge 1 (or 2)

Pattern 1 and Edge 1

Timeout

Terms that are grayed-out are not valid in the reset stage.

Triggering the Oscilloscope

To use Sequence triggering

- 2 Press the **Reset:** softkey and select a term to reset on.
- 3 Press the **Term** softkey and select the pattern, edge, or timeout term displayed in the **Reset:** softkey.
- 4 If you select **No Reset**, no reset stage will be defined.
- 5 If you select a pattern term, each channel in the pattern must be set to a **H** (high), **L** (low), or **X** (don't care).
 - a Press the **Channel** softkey (or rotate the Entry knob on mixed-signal oscilloscopes) to select the channel.
 - b Press the **L H X** softkey to set a level for the channel.
 - c Repeat for all channels in the pattern.
- 6 If you select an edge term, one channel must be set to a rising edge or a falling edge. All other channel edges will be set to don't care (X).
 - a Press the **Channel** softkey (or rotate the Entry knob on mixed-signal oscilloscopes) to select the channel.
 - b Then press the **↕ ↘ X** softkey to select rising edge or falling edge. All other channel edges will be defaulted to don't care.
- 7 If you select the **Timeout** term, you will need to set a timeout value.
 - a Press the **Term** softkey and select **Timeout**.
 - b Press the **Timeout** softkey, then turn the Entry knob to set the timeout value.

Timeout can be set from 100 ns to 10 seconds. The timer starts when the Find condition has been met. If the time is running and another Find condition occurs, the time will restart from time zero.

Adjust the trigger level for the selected analog channel by turning the **Trigger Level** knob. Select **Threshold** in the **D7 Thru D0** or **D15 Thru D8** menu to set the level for the digital channel group. The value of the trigger level or digital threshold is displayed in the upper-right corner of the display.

To use SPI triggering

Serial Peripheral Interface (SPI) trigger setup consists of connecting the oscilloscope to a clock, data, and framing signal. You can then trigger on a data pattern during a specific framing period. The serial data string can be specified to be from 4 to 32 bits long.

When you press the **Settings** softkey, a graphic will be displayed showing the current state of the frame signal, clock slope, number of data bits, and data bit values. Press the **Signals** softkey in the **Settings** menu to see the current source channels for the clock, data, and frame signals.

- Press the **More** key in the Trigger section of the front panel, rotate the Entry knob until **SPI** is displayed in the **Trigger** softkey, then press the **Settings** softkey to display the SPI trigger menu.

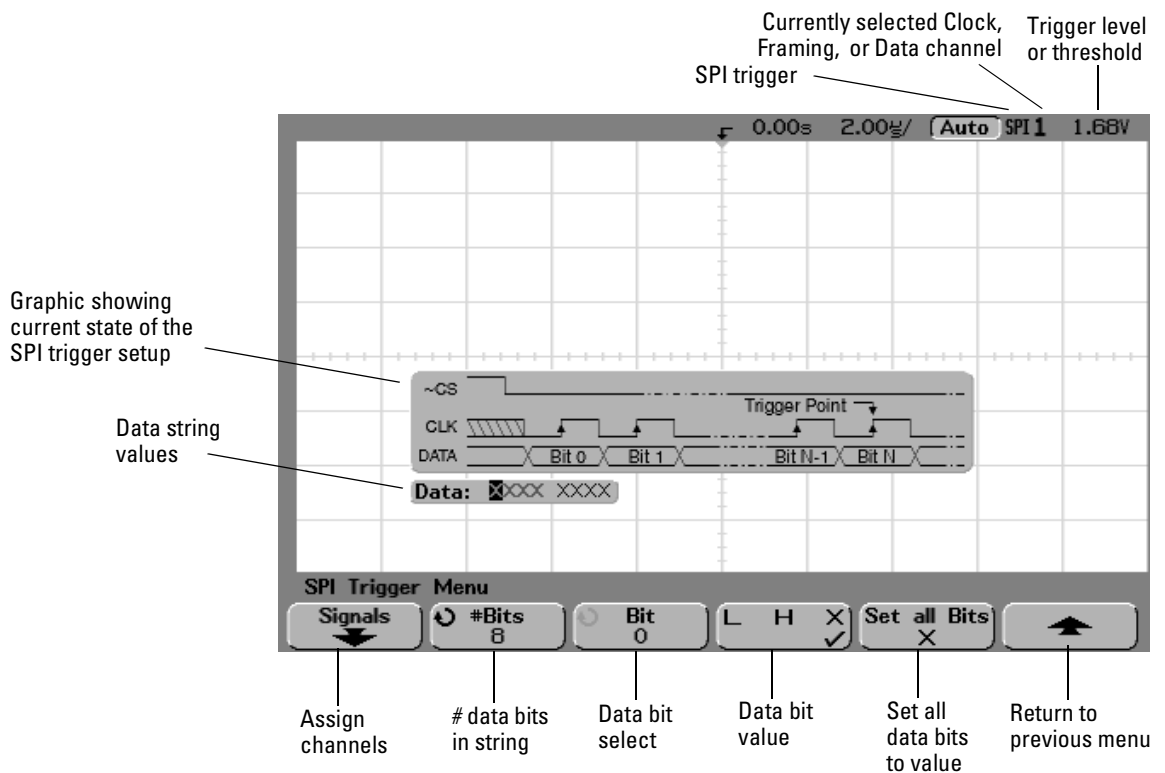

To use SPI triggering

Set up the number of bits in the serial data string and set values for those data bits

- 1 Turn the Entry knob to set the number of bits (**#Bits**) in the serial data string. The number of bits in the string can be set anywhere from 4 bits to 32 bits. The data values for the serial string are displayed in the Data string in the waveform area.
- 2 Turn the Entry knob to select a specific data bit in the serial string as shown in the **Bit** softkey.
As you rotate the Entry knob, the bit is highlighted in the Data string shown in the waveform area.
- 3 Press the **L H X** softkey to set the bit selected in the **Bit** softkey to **L** (low), **H** (high), or **X** (don't care).
Repeat steps 2 and 3 to assign values for all bits.

Resetting all bits in the serial data string to one value.

- To reset all of the bit values in the serial data string to one value (L, H, or X):
 - a Press the **L H X** softkey to select your reset bit value.
 - b Press the **Set all Bits** softkey to reset the data string to the selected value.

Assign source channels to the clock, data, and frame signals

- 1 Press the **Signals** softkey to access SPI trigger settings for clock source and slope, data source, and frame type and source.

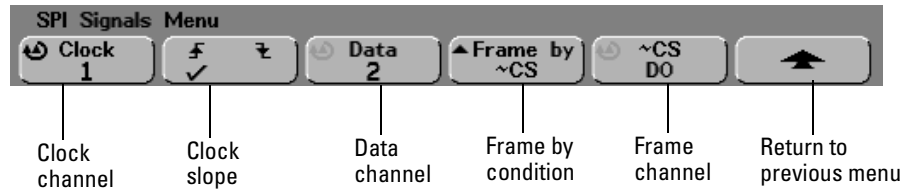

- 2 Press the **Clock** softkey or turn the Entry knob to select the channel connected to the SPI serial clock line. The **CLK** label for the source channel is automatically set.

As you press the **Clock** softkey (or rotate the Entry knob on mixed-signal oscilloscopes), the **CLK** label for the source channel is automatically set and the channel you select is shown in the upper-right corner of the display next to "SPI".

Adjust the trigger level for the selected analog channel by turning the Trigger Level knob. Select **Threshold** in the **D7 Thru D0** or **D15 Thru D8** menu to set the level for digital channels. The value of the trigger level or digital threshold is displayed in the upper-right corner of the display.

Triggering the Oscilloscope

To use SPI triggering

- 3 Press the slope softkey ($\uparrow \downarrow$) to select rising edge or falling edge for the selected Clock source.

This determines which clock edge the oscilloscope will use to latch the serial data. When you press the slope softkey, the graphic shown on the display changes to show the current state of the clock signal.

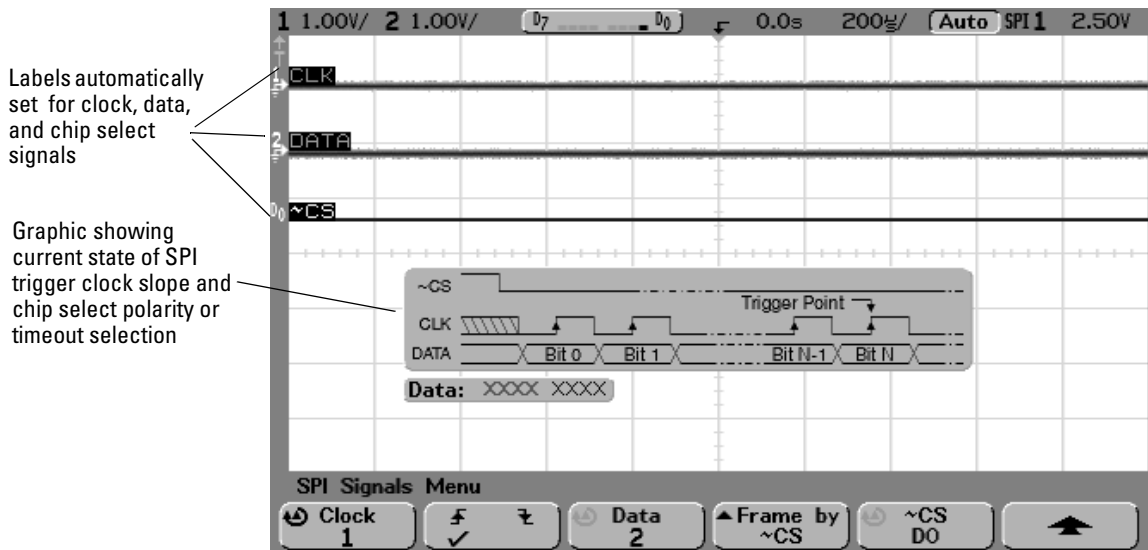

- 4 Press the **Data** softkey or turn the Entry knob to select the channel that is connected to the SPI serial data line. The **DATA** label for the source channel is automatically set.

As you press the **Data** softkey (or rotate the Entry knob on mixed-signal oscilloscopes), the **DATA** label for the source channel is automatically set and the channel you select is shown in the upper-right corner of the display next to "**SPI**".

Adjust the trigger level for the selected analog channel by turning the Trigger Level knob. Select **Threshold** in the **D7 Thru D0** or **D15 Thru D8** menu to set the level for digital channels. The value of the trigger level or digital threshold is displayed in the upper-right corner of the display.

- 5 Press the **Frame by** softkey to select a framing signal that the oscilloscope will use for determining which clock edge is the first clock edge in the serial stream.

You can set the oscilloscope to trigger during a high chip select (**CS**), a low chip select (**~CS**), or after a **Timeout** period during which the clock signal has been idle.

- If the framing signal is set to **CS**, the first clock edge as defined (rising or falling) seen after the **CS** signal transitions from low to high is the first clock in the serial stream.
- If the framing signal is set to **~CS**, the first clock edge as defined (rising or falling) seen after the **~CS** signal transitions from high to low is the first clock in the serial stream.
- If the framing signal is set to **Timeout**, the oscilloscope generates its own internal framing signal after it sees inactivity on the serial clock line.

Timeout Select **Timeout** in the **Frame by** softkey, then select the **Timeout** softkey and turn the Entry knob to set the minimum time that the Clock signal must be idle (not transitioning) before the oscilloscope will search for the Data pattern on which to trigger. When you press the **Frame by** softkey, the graphic shown on the previous page changes to show timeout selection or the current state of the chip select signal.

The Timeout value can be set anywhere from 500 ns to 10 s.

Chip Select Press the **CS** or **~CS** softkey or turn the Entry knob to select the channel that is connected to the SPI frame line. The label (**~CS** or **CS**) for the source channel is automatically set. The data pattern and the clock transition must occur during the time when the framing signal is valid. The framing signal must be valid for the entire data pattern.

As you press the **CS** or **~CS** softkey (or rotate the Entry knob on mixed-signal oscilloscopes), the **CS** or **~CS** label for the source channel is automatically set and the channel you select is shown in the upper-right corner of the display next to "**SPI**". When you press the **Frame by** softkey, the graphic shown on the previous page changes to show timeout selection or the current state of the chip select signal.

Adjust the trigger level for the selected analog channel by turning the Trigger Level knob. Select **Threshold** in the **D7 Thru D0** or **D15 Thru D8** menu to set the level for digital channels. The value of the trigger level or digital threshold is displayed in the upper-right corner of the display.

To use TV triggering

TV triggering is used to capture the complicated waveforms of television (TV) equipment. The trigger circuitry detects the vertical and horizontal interval of the waveform and produces triggers based on the TV trigger settings you have selected.

The oscilloscope's MegaZoom technology gives you bright, easily viewed displays of any part of the video waveform. Analysis of video waveforms is simplified by the oscilloscope's ability to trigger on any selected line of the video signal.

- 1 Press the **More** key in the Trigger section of the front panel, rotate the Entry knob until **TV** is displayed in the **Trigger** softkey, then press the **Settings** softkey to display TV trigger menu.

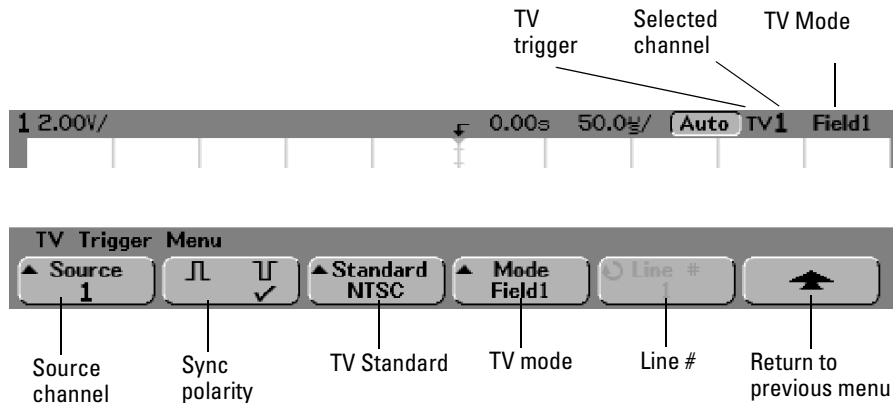

- 2 Press the **Source** softkey and select any analog channel as the TV trigger source.

The selected trigger source is displayed in the upper-right corner of the display. Turning the Trigger **Level** knob does not change the trigger level because the trigger level is automatically set to the sync pulse. Trigger coupling is automatically set to **TV** in the Trigger **Mode/Coupling** menu.

Provide Correct Matching

Many TV signals are produced from 75 Ω sources. To provide correct matching to these sources, a 75 Ω terminator (such as an Agilent 11094B) should be connected to the oscilloscope input.

- 3 Press the sync polarity softkey to set the TV trigger to either positive (\sqcap) or negative (\sqcup) sync polarity.
- 4 Press the **Standard** softkey to set the TV standard.
The oscilloscope supports triggering on NTSC, PAL, PAL-M, SECAM, and Generic television (TV) and video standards. NTSC, PAL, PAL-M, and SECAM are broadcast standards used throughout the world. Generic allows you to trigger on progressive scan and other non-broadcast video signals.
- 5 Press the **Mode** softkey to select the TV triggering mode
The TV trigger modes available are:
 - Field1** and **Field2** - trigger on the rising edge of the first serration pulse of field 1 or field 2.
 - All Fields** - trigger on the rising edge of the first serration pulse of both field 1 and field 2 (not available in Generic mode).
 - All Lines** - trigger on the first line found.
 - Line: Field1** and **Line:Field2** - trigger on the selected line # in field 1 or field 2.
 - Line: Alternate** - alternately trigger on the selected line # in field 1 and field 2 (not available in Generic mode).
 - Vertical** - trigger on the rising edge of the first serration pulse or ~ 70 us after the start of vertical sync, whichever occurs first (only available in Generic mode).
 - Count: Vertical** - counts falling edges of sync pulses; triggers on the selected count # (only available in Generic mode).

To use TV triggering

- 6 If you select a line mode when using standards NTSC, PAL, PAL-M, or SECAM, press the **Line #** softkey, then rotate the Entry knob to select the line number on which you want to trigger.
- 7 If you select a line mode when using the Generic standard, press the **Count #** softkey, then rotate the Entry knob to select the desired count number.

Listed below are the line (or count) numbers per field for each TV standard.

Line (or count for Generic) numbers per field for each TV standard

TV standard	Field 1	Field 2	Alt Field
NTSC	1 to 263	1 to 262	1 to 262
PAL	1 to 313	314 to 625	1 to 312
PAL-M	1 to 263	264 to 525	1 to 262
SECAM	1 to 313	314 to 625	1 to 312
Generic	1 to 1024	1 to 1024	1 to 1024 (vertical)

Example exercises

The following are exercises to familiarize you with TV triggering.

To trigger on a specific line of video

TV triggering requires greater than 1/2 division of sync amplitude with any analog channel as the trigger source. Turning the trigger **Level** knob in TV trigger does not change the trigger level because the trigger level is automatically set to the sync pulse tips.

One example of triggering on a specific line of video is looking at the vertical interval test signals (VITS), which are typically in line 18. Another example is closed captioning, which is typically in line 21.

- 1 Press the Trigger **More** key, then press the **TV** softkey.
- 2 Press the **Settings** softkey, then press the **Standard** softkey to select the appropriate TV standard.
- 3 Press the **Mode** softkey and select the TV field of the line you want to trigger on. You can choose **Line:Field1**, **Line:Field2**, or **Line:Alternate**.
- 4 Press the **Line #** softkey and select the number of the line you want to examine.

Alternate Triggering

If **Line:Alternate** is selected, the oscilloscope will alternately trigger on the selected line number in Field 1 and Field 2. This is a quick way to compare the Field 1 VITS and Field 2 VITS or to check for the correct insertion of the half line at the end of Field 1.

When using **Generic** as the TV standard, you can select a line number to trigger on when **Mode** is set to **Line:Field1**, **Line:Field2** and **Count:Vertical**.

Triggering the Oscilloscope

To use TV triggering

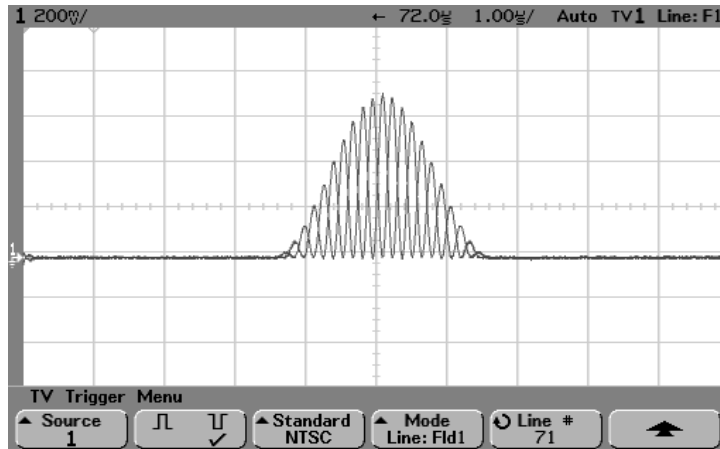

Triggering on Line 71

Line Numbers per Field for Each TV Standard

TV Standard	Field 1	Field 2	Alt Fld
NTSC	1 to 263	1 to 262	1 to 262
PAL	1 to 313	314 to 625	1 to 313
PAL-M	1 to 263	264 to 525	1 to 263
SECAM	1 to 313	314 to 625	1 to 313
GENERIC	1 to 1024	1 to 1024	1 to 1024 (Vertical)

Line Number Represents Count

In **Generic** mode, the line number represents the number of a count instead of a real line number. This is reflected in the label in the softkey changing from **Line** to **Count**. In the **Mode** softkey selections, **Line:Field 1**, **Line:Field 2** and **Count:Vertical** are used to indicate where the counting starts. For an interlaced TV system, the counting starts from the rising edge of the first vertical serration pulse of Field 1 and/or Field 2. For a non-interlaced TV system, the counting starts after the rising edge of the vertical sync pulse.

To trigger on all TV line sync pulses

To quickly find maximum video levels, you could trigger on all TV line sync pulses. When All Lines is selected as the TV trigger mode, the oscilloscope will trigger on the first line that it finds when the acquisition starts.

- 1 Press the Trigger **More** key, then press the **TV** softkey.
- 2 Press the **Settings** softkey, then press the **Standard** softkey to select the appropriate TV standard.
- 3 Press the **Mode** softkey and select **All Lines**.

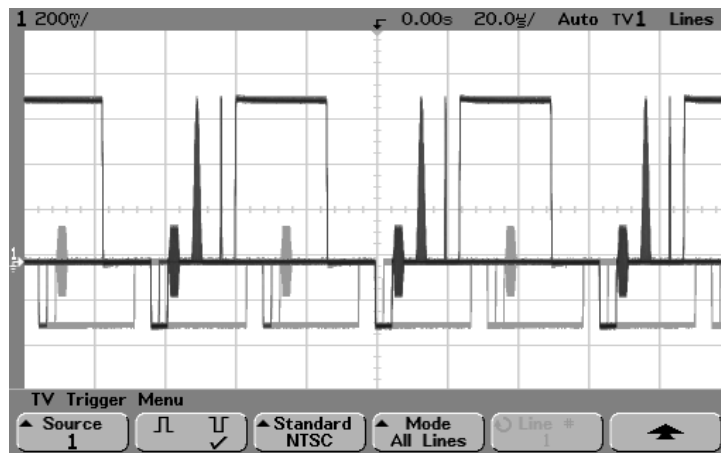

Triggering on All Lines

To use TV triggering

To trigger on a specific field of the video signal

To examine the components of a video signal, trigger on either Field 1 or Field 2. When a specific field is selected, the oscilloscope triggers on the rising edge of the first serration pulse in the vertical sync interval in the specified field (1 or 2).

- 1 Press the Trigger **More** key, then press the **TV** softkey.
- 2 Press the **Settings** softkey, then press the **Standard** softkey to select the appropriate TV standard.
- 3 Press the **Mode** softkey and select **Field1** or **Field2**.

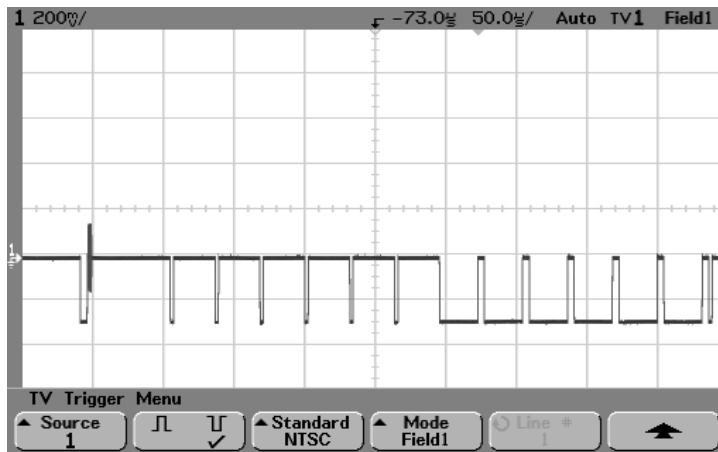

Triggering on Field 1

To trigger on all fields of the video signal

To quickly and easily view transitions between fields, or to find the amplitude differences between the fields, use the All Fields trigger mode. The oscilloscope will trigger on the first field it finds at the start of acquisition.

- 1 Press the Trigger **More** key, then press the **TV** softkey.
- 2 Press the **Settings** softkey, then press the **Standard** softkey to select the appropriate TV standard.
- 3 Press the **Mode** softkey and select **All Fields**.

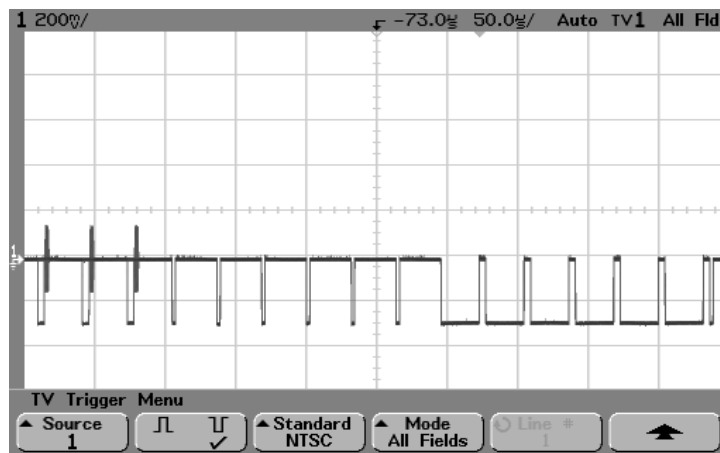

Triggering on All Fields

To use TV triggering

To trigger on odd or even fields

To check the envelope of your video signals, or to measure worst case distortion, trigger on the odd or even fields. When Field 1 is selected, the oscilloscope triggers on color fields 1 or 3. When Field 2 is selected, the oscilloscope triggers on color fields 2 or 4.

- 1 Press the Trigger **More** key, then press the **TV** softkey.
- 2 Press the **Settings** softkey, then press the **Standard** softkey to select the appropriate TV standard.
- 3 Press the **Mode** softkey and select **Field1** or **Field2**.

The trigger circuits look for the position of the start of Vertical Sync to determine the field. But this definition of field does not take into consideration the phase of the reference subcarrier. When Field 1 is selected, the trigger system will find any field where the vertical sync starts on Line 4. In the case of NTSC video, the oscilloscope will trigger on color field 1 alternating with color field 3 (see the following figure). This setup can be used to measure the envelope of the reference burst.

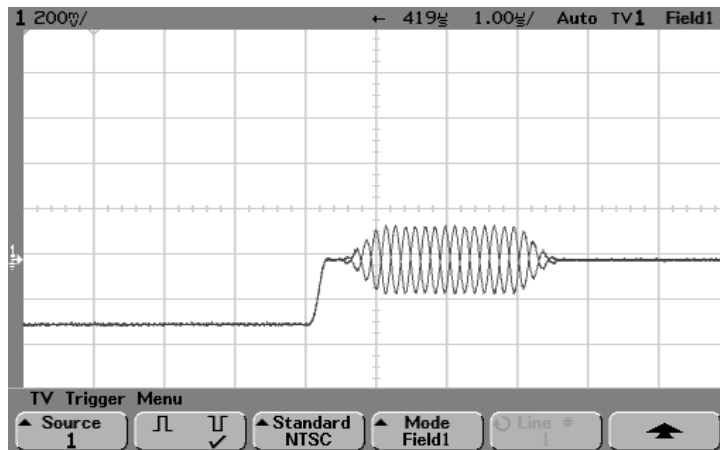

Triggering on Color Field 1 Alternating with Color Field 3

If a more detailed analysis is required, then only one color field should be selected to be the trigger. You can do this by using the trigger **Holdoff** softkey in the trigger **Mode/Coupling** menu. Using the holdoff settings shown in the following table, the oscilloscope will now trigger on color field 1 OR color field 3 when Field 1 is selected. This is known as odd field selection. Even fields will be selected with Field 2.

Holdoff Settings

Video Standard	Fields/Picture	Holdoff Range
NTSC	4	33.5 ms to 50.0 ms
PAL	8	80.7 ms to 120 ms
SECAM	4	40.4 ms to 60 ms
PAL-M	8	80.4 ms to 120 ms

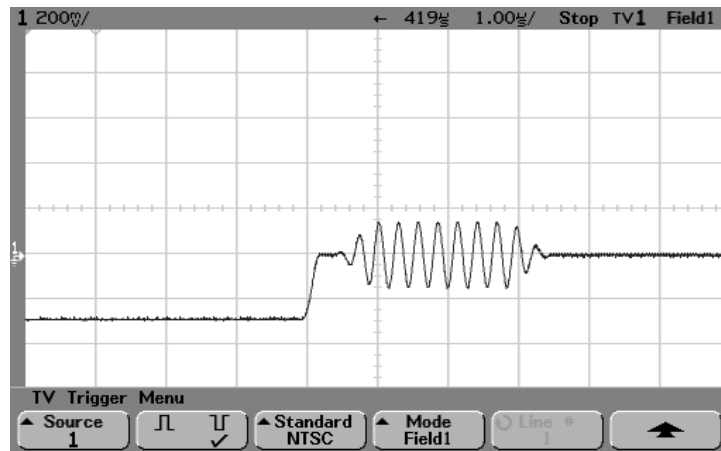

Triggering on Color Field 1 using Holdoff (single-shot)

To use USB triggering

USB trigger will trigger on a Start of Packet (SOP), End of Packet (EOP) signal, Reset Complete (RC), Enter Suspend (Suspend), or Exit Suspend (Exit Sus) on the differential USB data lines (D+ and D-). USB Low Speed and Full Speed are supported by this trigger.

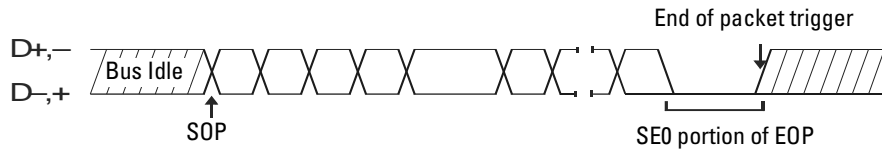

- 1 Press the **More** key in the Trigger section of the front panel, rotate the Entry knob until **USB** is displayed in the **Trigger** softkey, then press the **Settings** softkey to display USB trigger menu.

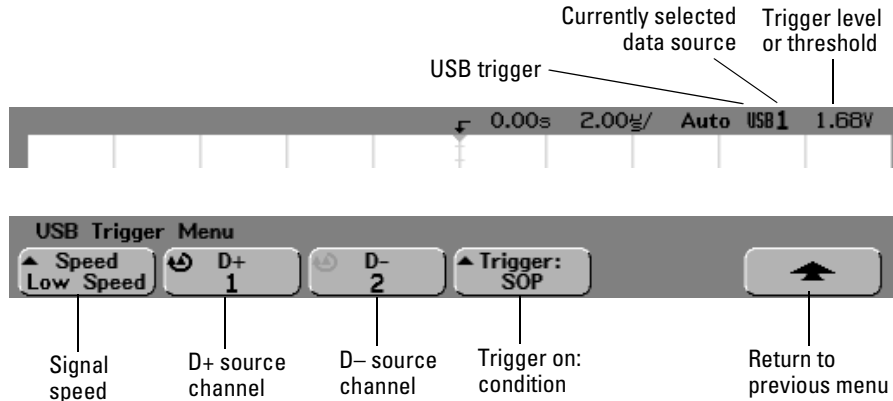

- 2 Press the **Speed** softkey to select the speed of the transaction being probed.
You may select Low Speed (1.5 Mb/s) or Full Speed (12 Mb/s).

- 3 Press the **D+** and **D-** softkeys to select the channel connected to the USB signal D+ and D- lines. The **D+** and **D-** labels for the source channels are automatically set.

As you press the **D+** or **D-** softkey (or rotate the Entry knob on mixed-signal oscilloscopes), the **D+** and **D-** label for the source channel is automatically set and the channel you select is shown in the upper-right corner of the display next to "**USB**".

Adjust the trigger level for the selected analog channel by turning the Trigger Level knob. Select **Threshold** in the **D7 Thru D0** or **D15 Thru D8** menu to set the level for digital channels. The value of the trigger level or digital threshold is displayed in the upper-right corner of the display.

- 4 Press the **Trigger:** softkey to select where the USB trigger will occur:
 - SOP** (Start of Packet) - triggers at the Sync bit at the beginning of the packet.
 - EOP** (End of Packet) - triggers at the end of the SE0 portion of the EOP.
 - RC** (Reset Complete) - triggers when SE0 is > 10 ms.
 - Suspend** (Enter Suspend) - triggers when the bus is idle > 3 ms.
 - Exit Sus** (Exit Suspend) - triggers when exiting an idle state > 10 ms. This is used to see the suspend/resume transition.

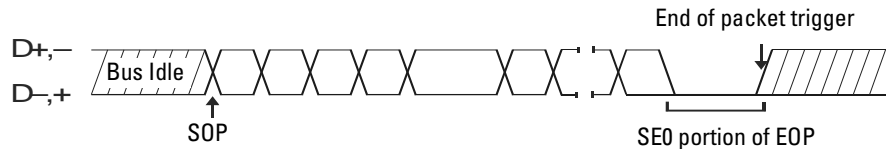

The Trigger Out connector

The oscilloscope sends a pulse to the Trigger Out BNC connector on the rear panel of the oscilloscope when a trigger event occurs. This pulse is typically used to trigger other test equipment. The Trig Out is a 0 to 5 V signal designed to drive a 50Ω load. The rising edge of the pulse is the trigger point and is delayed (~ 55 ns for 54620-series and ~ 22 ns for 54640-series) from the oscilloscope trigger point.

The Trigger Out connector also provides the user calibrator signal on the 54640-series oscilloscopes when performing a **User Cal** from the **Utility Service** menu. For more information on User Cal, refer to “*To perform service functions*” in the “Utilities” chapter of this guide.



MegaZoom Concepts and Oscilloscope Operation

MegaZoom Concepts and Oscilloscope Operation

This chapter gives an overview of some oscilloscope concepts that will help you make better measurements. It discusses the relationship between the time base setting and other time-dependent oscilloscope functions, explains how to achieve the most accurate signal fidelity through good probing practices, and describes how glitch detection works.

MegaZoom Concepts

MegaZoom technology combines the advantages of conventional deep-memory digital oscilloscopes with the responsiveness and update rate of traditional analog oscilloscopes. Conventional deep-memory digital oscilloscopes are known for their ability to capture long time intervals while still maintaining high sample rates. MegaZoom technology keeps the deep-memory advantages, without the usual deep-memory disadvantages of an unresponsive user interface (while panning and zooming through the data) and poor signal update rate.

MegaZoom technology incorporates a multi-processor architecture in the signal data path between the oscilloscope probe and the oscilloscope display. This yields an instrument that responds instantly to pan and zoom controls while exploring the acquired data. MegaZoom technology combines update rate, instant control response, and deep-memory innovations to allow you to capture long time periods with high sample rates, and instantly zoom in on the signal details of interest either while stopped or running. Deep-memory, front-panel responsiveness and display update rate are combined into one oscilloscope, with no need for a special mode or memory depth selection.

Deep Memory

The primary advantage of a deep-memory oscilloscope is sustained sample rate, allowing you to capture at the maximum sample rate and still capture a long time window. For example, you may want to capture a fast digital event, such as an interrupt line being asserted, while being able to look far out in time to see when the line was de-asserted. This may require a fast sample rate to examine the signal fidelity of the interrupt edge, and also long-time capture to determine how long the interrupt line was asserted.

Another advantage is the ability to capture relatively longer periods of time or slow time-per-division settings at an adequate sample rate. This allows you to capture a long event, such as an oscillator starting up, or two events separated by a long time, such that you can see the entire time frame of interest. To see the event, the oscilloscope must have captured the information at a fast enough sample rate so that you can see the interesting details.

Thus there are two major benefits of deep memory. First, long time spans can be captured and then zoomed-in on for detailed analysis. Second, the deep memory is displayed to the high-definition display with 32 levels of intensity for more insight into the signal. This is particularly of value when dealing with mixed analog and digital designs where slow analog events require long time spans and fast digital control signals require the ability to maintain the sample rate so interactions may be viewed in detail.

Memory depth values

54620-series	2 MB/ analog channel, 4MB max with single analog channel in Single mode. 8 MB/digital channel single pod, 4 MB/digital channel with 2 pods in use.
54640-series	4 MB/ analog channel, 8MB max with single analog channel in Single mode. 4 MB/digital channel single pod, 4 MB/digital channel with 2 pods in use.

Oscilloscope Responsiveness

An important element of an oscilloscope is how responsive it is to control changes. After a control is changed, such as the time/division, if you must wait for the test instrument to respond, the feedback loop between the instrument and the user can become difficult. You could confuse adjustments because of the delay between making a change to the instrument and seeing the effect of that change take place.

MegaZoom Technology

In MegaZoom technology, the primary task of processing acquisition memory into oscilloscope waveforms using proprietary display techniques is distributed to waveform acquisition and rendering hardware. The processor's primary responsibility is to scan the keyboard and manage I/O ports. Because the dedicated waveform translator can draw waveforms quickly, without interrupting the processor, the processor is dedicated to the user interface tasks. User input is acted upon immediately and the oscilloscope display very quickly reflects the user's changes. This results in the highly-responsive MegaZoom oscilloscope display.

Display Update Rate

In analog oscilloscopes, the oscilloscope is blind while the electron beam is reset to the left side of the screen. Thus, the update rate of an analog oscilloscope seems high because the blind or dead time of the analog scope is low.

Infrequent or random events that happen while the oscilloscope is blind are missed, and thus not displayed. Oscilloscope users often assume that their scope is capturing the entire waveform and that the update rate is perfect, when the oscilloscope display is actually missing some events. If we could eliminate this dead time, their assumption would be correct.

MegaZoom technology maintains high update rate by using parallel processing and memory segmentation. The MegaZoom oscilloscope flows samples into one area of acquisition memory, and in another area they are read out and processed into displayed samples. By doing this, the processing part of the update cycle does not miss any events. This results in very fast update rate and a responsive user interface.

To setup the Analog channels

- 1 Press the **1** key in the Vertical section (Analog section on mixed-signal oscilloscopes) of the front panel to display the channel 1 menu.

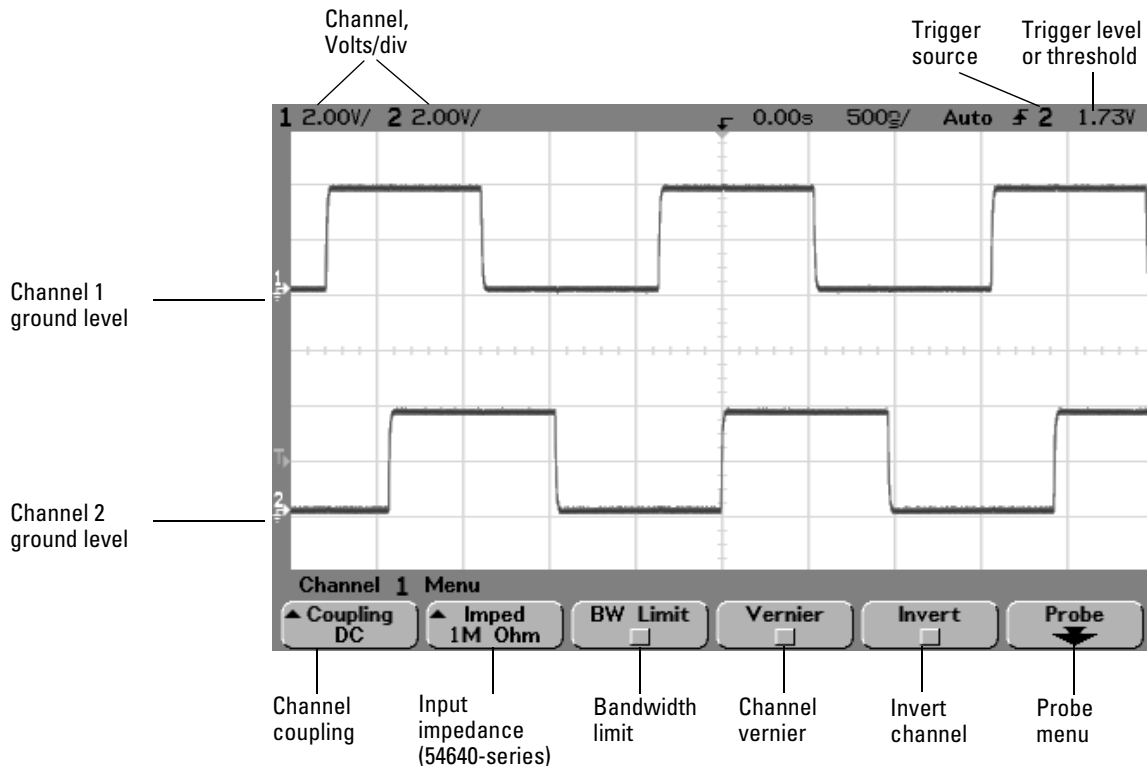

Pressing an analog channel key turns the display of the channel on or off. The channel is displayed when the key is illuminated.

Turning channels off



If more than one channel is turned on (channel keys are illuminated), you must be viewing the menu for a channel before you can turn it off. For example, if channel 1 and channel 2 are turned on and the menu for channel 2 is being displayed, to turn channel 1 off, press **1** to display channel 1 menu, then press **1** again to turn channel 1 off.

To setup the Analog channels

Vertical sensitivity Turn the large knob above the channel key to set the sensitivity (volts/division) for the channel. The volts/division knob changes the analog channel sensitivity from 1 mV to 5 V for the 54620-series and from 2 mV to 5 V for the 54640-series in a 1-2-5 step sequence with a 1:1 probe attached. The analog channel Volts/Div value is displayed in the status line.

Vertical expansion The default mode for expanding the signal when you turn the volts/division knob is vertical expansion about the ground level. To set the expansion mode to expand about the center of the screen instead, press **Expand** in the **Utility Options** menu and select **Center**.

Ground level The ground level of the signal for each displayed analog channel is identified by the position of the  icon at the far-left side of the display.

Channel position Turn the small channel position knob () to move the channel waveform up or down on the display. The voltage value momentarily displayed in the upper right portion of the display represents the voltage difference between the center graticule and the ground level () icon. It also represents the voltage at the center graticule.

2 Press the **Coupling** softkey to select the input channel coupling.

Coupling changes the channel's input coupling to either **AC** (alternating current), **DC** (direct current), or **Ground** (hardware ground on 54620-series only). AC coupling places a 3.5 Hz high-pass filter in series with the input waveform that removes any DC offset voltage from the waveform. When **AC** is selected, "AC" is illuminated on the front panel next to the channel position knob ()

- DC coupling is useful for viewing waveforms as low as 0 Hz that do not have large DC offsets.
- AC coupling is useful for viewing waveforms with large DC offsets, or with slowing moving DC offsets.
- Ground coupling (54620-series only) is useful for removing clutter on screen, estimating the baseline noise contribution by the oscilloscope, and measuring the difference between oscilloscope ground and device-under-test ground.

3 Press the **Imped** (impedance) softkey

The 54620-series oscilloscope analog channel input impedance is always 1 M Ω . The 54640-series oscilloscope analog channel input impedance can be set to either **1M Ohm** or **50 Ohm** by pressing the **Imped** softkey.

- **50 Ohm** mode matches 50-ohm cables commonly used in making high frequency measurements. This impedance matching gives you the most accurate measurements since reflections are minimized along the signal path.
- **1M Ohm** mode is for use with probes and for general-purpose measurements. The higher impedance minimizes the loading effect of the oscilloscope on the circuit under test.

When you connect an AutoProbe self-sensing probe, the oscilloscope will automatically configure your probe to the correct impedance.

4 Press the **BW Limit** softkey to turn on bandwidth limiting.

Pressing the **BW Limit** softkey turns the bandwidth limit on or off for the selected channel. When bandwidth limit is on, the maximum bandwidth for the channel is approximately 20 MHz for 54620-series and 25 MHz for 54640-series. For waveforms with frequencies below this, turning bandwidth limit on removes unwanted high frequency noise from the waveform. Bandwidth limit also limits the trigger signal path if the channel you are configuring is the trigger source. When **BW Limit** is selected, “BW” is illuminated on the front panel next to the channel position knob (\blacklozenge).

5 Press the **Vernier** softkey to turn on vernier for the selected channel.

When Vernier is selected, you can change the channel sensitivity in smaller increments with the volts/division knob. The channel sensitivity remains fully calibrated when Vernier is on. The vernier value is displayed in the status line at the top of the display.

When Vernier is turned off, turning the volts/division knob changes the channel sensitivity in a 1-2-5 step sequence.

6 Press the **Invert** softkey to inverted the selected channel.

When Invert is selected, the voltage values of the displayed waveform are inverted. Invert affects how a channel is displayed, but does not affect triggering. If the oscilloscope is set to trigger on a rising edge, it remains set to trigger on a same edge (triggers at the same point on the waveform) after the channel is inverted.

Inverting a channel will also change the result of any function selected in the Math menu or any measurement.

To setup the Analog channels**7 Press the Probe softkey to display the channel probe menu.**

This menu allows you to select additional probe parameters such as attenuation factor and units of measurement for the connected probe.

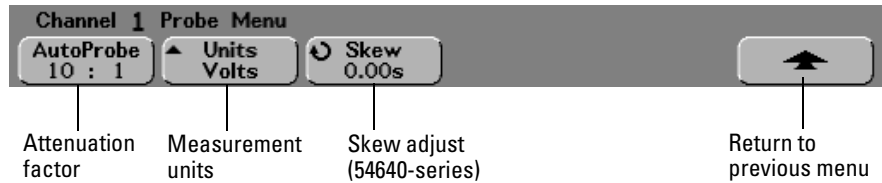

Probe Attenuation If you have an AutoProbe self-sensing probe (such as the 10073C or 10074C) connected to the analog channel, the oscilloscope will automatically configure your probe to the correct attenuation factor. In the previous figure, the oscilloscope has sensed an AutoProbe 10:1 probe.

If you do not have a self-sensing probe connected, press the **Probe** softkey and turn the Entry knob to set the attenuation factor for the connected probe. The attenuation factor can be set from 0.1:1 to 1000:1 in a 1-2-5 sequence.

The probe correction factor must be set properly for measurements to be made correctly.

Probe Units Press the **Units** softkey to select the proper measurement unit for the connected probe. Select **Volts** for a voltage probe and select **Amps** for a current probe. Channel sensitivity, trigger level, measurement results, and math functions will reflect the measurement units you have selected.

Skew (54640-series only) Turn the Entry knob to enter the amount of skew between analog channel 1 and 2. Each analog channel can be adjusted ± 100 ns for a total of 200 ns difference.

The skew setting is not affected by pressing **Autoscale**. If you press the **Default Setup** softkey in the **Save/Recall** menu, the skew value will return to zero seconds.

When measuring time intervals in the ns range, small differences in cable length can totally obscure the measurement. Use **Skew** to remove cable-delay errors between channel 1 and channel 2.

To setup the Horizontal time base

- 1 Press the **Main/Delayed** key in the Horizontal section of the front panel.

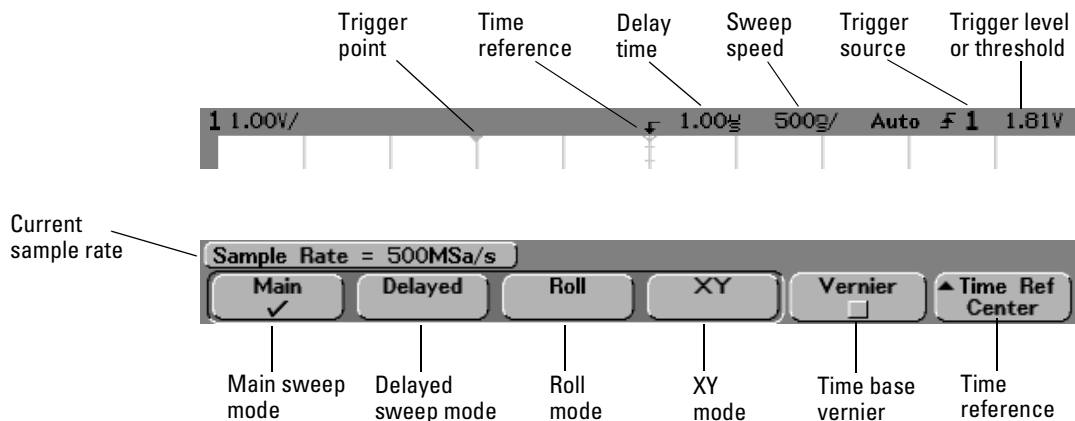

The Main/Delayed menu allows you to select the horizontal mode (Main, Delayed, Roll, or XY), and set the time base vernier and time reference.

Main mode

- 2 Press the **Main** softkey to select Main horizontal mode.

Main horizontal mode is the normal viewing mode for the oscilloscope. When the oscilloscope is stopped, you can use the Horizontal knobs to pan and zoom the waveform.

- 3 Turn the large knob (time/division) in the Horizontal section and notice the change it makes to the status line.

When the oscilloscope is running in Main mode, use the large Horizontal knob to change sweep speed and use the small knob (◀▶) to set the delay time. When the oscilloscope is stopped, use these knobs to pan and zoom your waveform. The time/division knob changes the sweep speed from 5 ns to 50 s for the 54620-series and from 1 ns to 50 s for the 54640-series in a 1-2-5 step sequence. The sweep speed (seconds/division) value is displayed in the status line.

To setup the Horizontal time base

4 Press the Vernier softkey to turn on the time base vernier.

The **Vernier** softkey allows you to change the sweep speed in smaller increments with the time/division knob. The sweep speed remains fully calibrated when Vernier is on. The value is displayed in the status line at the top of the display.

When Vernier is turned off, the Horizontal sweep speed knob changes the time base sweep speed in a 1-2-5 step sequence.

5 Note the setting of the Time Ref (time reference) softkey.

Time reference is the reference point on the display for delay time. Time reference can be set to one graticule from the left or right edge, or to the center of the display.

A small hollow triangle (∇) at the top of the graticule marks the position of the time reference. When delay time is set to zero, the trigger point indicator (▼) overlays the time reference indicator.

Turning the Horizontal sweep speed knob will expand or contract the waveform about the time reference point (∇). Turning the Horizontal delay time (◀▶) knob in Main mode will move the trigger point indicator (▼) to the left or right of the time reference point (∇).

The time reference position sets the initial position of the trigger event within acquisition memory and on the display, with delay set to 0. The delay setting sets the specific location of the trigger event with respect to the time reference position. The time reference setting affects the delayed sweep as described in the following ways:

- When the horizontal mode is set to Main, the delay positions the main sweep relative to the trigger. This delay is a fixed number. Changing this delay value does not affect the sweep speed.
- When the horizontal mode is set to Delayed, the delay controls the position of the delayed sweep window inside the main sweep display. This delayed delay value is independent of sampling interval and sweep speed. Changing this delay value does not effect the position of the main window.

6 Turn the delay knob (◀▶) and notice that its value is displayed in the status line.

Changing the delay time moves the sweep horizontally and indicates how far the trigger point (▼) is from the time reference point (∇). These reference points are indicated along the top of the graticule. The previous figure shows the trigger point with the delay time set to 1.00 μs . The delay time number tells you how far the time reference point ∇ is located from the trigger point ▼. When delay time is set to zero, the delay time indicator overlays the time reference indicator.

All events displayed left of the trigger point (▼) happened before the trigger occurred, and these events are called pre-trigger information. You will find this feature very useful because you can now see the events that led up to the trigger point. Everything to the right of the trigger point (▼) is called post-trigger information. The amount of delay range (pre-trigger and post-trigger information) available depends on the sweep speed selected. This range is much larger than that on an oscilloscope without deep memory.

To setup the Horizontal time base

Delayed mode

Delayed sweep is an expanded version of main sweep. When Delayed mode is selected, the display divides in half and the delayed sweep  icon displays in the middle of the line at the top of the display. The top half of the display has the main sweep and the bottom half has the delayed sweep.

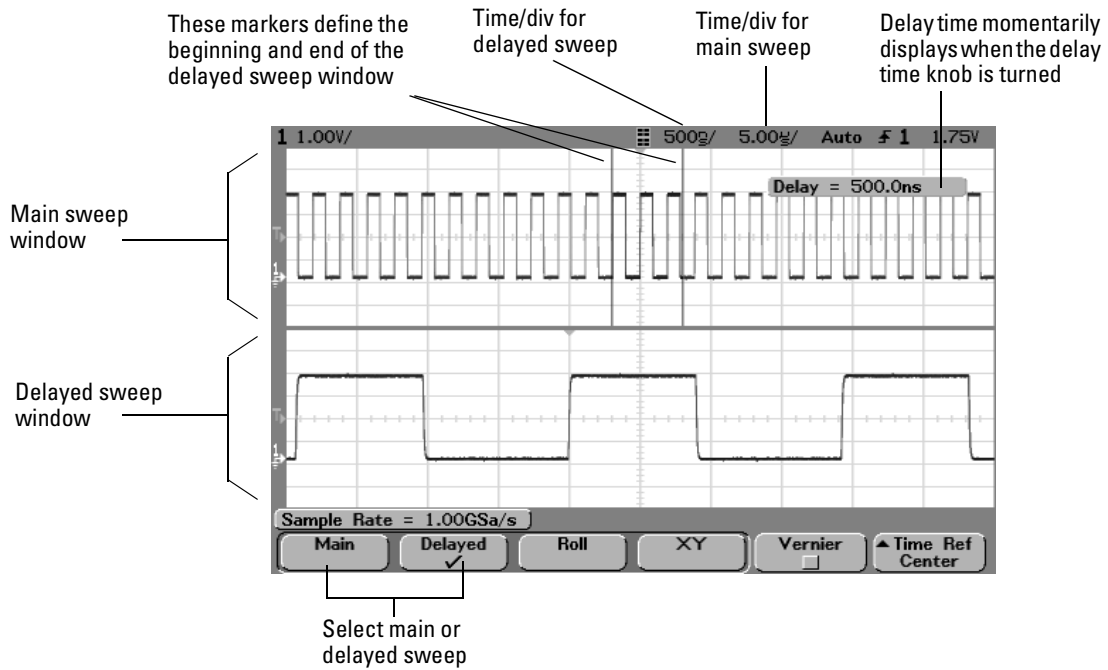

The area of the main display that is expanded is intensified and marked on each end with a vertical marker. These markers show what portion of the main sweep is expanded in the lower half. The Horizontal knobs control the size and position of the delayed sweep. The delay value is momentarily displayed in the upper-right portion of the display when the delay time ($\blacktriangleleft\blacktriangleright$) knob is turned.

To change the sweep speed for the delayed sweep window, turn the sweep speed knob. As you turn the knob, the sweep speed is highlighted in the status line above the waveform display area.

The time reference position sets the initial position of the trigger event within acquisition memory and on the display, with delay set to 0. The delay setting sets the specific location of the trigger event with respect to the time reference position. The time reference setting affects the delayed sweep as described in the following ways.

When the horizontal mode is set to Main, the delay positions the main sweep relative to the trigger. This delay is a fixed number. Changing this delay value does not affect the sweep speed. When the horizontal mode is set to Delayed, the delay controls the position of the delayed sweep window inside the main sweep display. This delayed delay value is independent of sampling interval and sweep speed.

To change the sweep speed for the main sweep window, press the **Main** softkey, then turn the sweep speed knob.

For information about using delayed mode for measurements, refer to the “Making Measurements” chapter.

To setup the Horizontal time base

Roll mode

Roll mode causes the waveform to move slowly across the screen from right to left. It only operates on time base settings of 500 ms/div and slower. If the current time base setting is faster than the 500 ms/div limit, it will be set to 500 ms/div when Roll mode is entered.

In Normal horizontal mode, signal events occurring before the trigger are plotted to the left of the trigger point (▼) and signal events after the trigger plotted to the right of the trigger point.

In Roll mode there is no trigger. The fixed reference point on the screen is the right edge of the screen and refers to the current moment in time. Events that have occurred are scrolled to the left of the reference point. Since there is no trigger, no pre-trigger information is available.

If you would like to clear the display and restart an acquisition in Roll mode, press the **Single** key.

Use Roll mode on low-frequency waveforms to yield a display much like a strip chart recorder. It allows the waveform to roll across the display.

XY mode

XY mode changes the display from a volts-versus-time display to a volts-versus-volts display. The time base is turned off, and Channel 1 amplitude is plotted on the X-axis and Channel 2 amplitude is plotted on the Y-axis.

You can use XY mode to compare frequency and phase relationships between two signals. XY mode can also be used with transducers to display strain versus displacement, flow versus pressure, volts versus current, or voltage versus frequency.

Use the cursors to make measurements on XY mode waveforms.

For more information about using XY mode for measurements, refer to the “Making Measurements” chapter.

Acquisition Modes

Remember how when using your analog oscilloscope you had to constantly adjust the brightness? You did this to see the desired level of detail in a signal, or sometimes to see the signal at all!

The INTENSITY knob on the Agilent 54620/40-series oscilloscopes works like an analog oscilloscope; it changes how the frequency of occurrence of waveform portions are mapped into various brightness levels. The INTENSITY knob allows you to adjust the plotted waveforms to account for various signal characteristics, such as fast sweep speeds and low trigger rates. Even the least frequent events are drawn at a dim, but visible level. Turning the knob fully clockwise will make even the most infrequent waveform bright and easy to see

In the 54620/40-series oscilloscopes, you control the detail by selecting an acquisition mode:

- Normal
 - Peak Detect
 - Average
 - Realtime
- Press the **Acquire** key to display the Acquire menu.



Acquisition Modes

Normal Mode

For the majority of use models and signals, Normal acquisition mode yields the best oscilloscope picture of the waveform.

The analog channels can have up to 2 million samples per channel for the 54620-series and up to 4 million samples per channel for the 54640-series behind the 1,000-pixel column oscilloscope display. Some compression of samples to display points is obviously necessary, but due to the high plot rate (up to 25 million vectors/second), the compression is much less than previous oscilloscopes. This means the signal will look “right” at many more operating points.

All points displayed after Single or Stop

After a Single acquisition or when the oscilloscope has been stopped, all acquired points are displayed.

Peak Detect

Peak Detect is useful if you are interested in capturing a narrow event relative to the time window of interest. Using Peak Detect and infinite persistence together is a powerful way to find spurious signals and glitches.

54620-series Peak detect acquire mode displays any signal pulse wider than 5 ns, allowing you to find glitches and narrow spikes regardless of sweep speed. Because of MegaZoom memory, peak detect is only necessary at sweep speeds of 1 ms/div and slower. At faster sweep speeds, Normal acquire mode can capture the narrow peaks.

At sweep speeds slower than 1 ms/div, the oscilloscope can acquire more samples than can fit into MegaZoom memory. The oscilloscope selects samples to store such that no local minimum or maximum wider than 5 ns is missed. In peak detect mode, narrow glitches and sharp edges are displayed more brightly than when in Normal acquire mode, making them easier to see.

54640-series Peak detect acquire mode displays any signal pulse wider than 1 ns, allowing you to find glitches and narrow spikes regardless of sweep speed. Because of MegaZoom memory, peak detect is only necessary at sweep speeds of 500 μ s/div and slower. At faster sweep speeds, Normal acquire mode can capture the narrow peaks.

At sweep speeds slower than 500 μ s/div, the oscilloscope can acquire more samples than can fit into MegaZoom memory. The oscilloscope selects samples to store such that no local minimum or maximum wider than 1 ns is missed. In peak detect mode, narrow glitches and sharp edges are displayed more brightly than when in Normal acquire mode, making them easier to see.

Average Mode

Averaging lets you average multiple triggers together to reduce noise and increase resolution. Averaging of multiple triggers requires a stable trigger. The number of triggers being averaged is displayed in the **# Avgs** softkey.

- Turn the Entry knob to set the number of averages (**# Avgs**) that best eliminates the noise from the displayed waveform.

The number of averages can be set from 1 to 16383 in powers-of-2 increments. The higher the number of averages you set, the more noise reduction and resolution enhancement will be accomplished.

# Avgs	Bits of resolution
1	8
4	9
16	10
64	11
256	12

High-resolution mode (# Avgs=1)

High-resolution mode is an oversampling technique used when the digitizer sampling rate is faster than the rate at which samples are being stored into acquisition memory. For example, if the oscilloscope is sampling at 200 MSa/s, yet storing the samples at 1 MSa/s, it needs to store only 1 out of every 200 samples. When high-resolution mode is used, the slower the sweep speed, the greater the number of samples that are averaged together for each display point. This tends to reduce random noise on the input signal, which produces a smoother trace on the screen.

Acquisition Modes

If you cannot acquire multiple triggers, you can still reduce noise and increase resolution at slower sweep speeds by setting **# Avgs** to **1**.

54620-series Sweep speed	54640-series Sweep speed	Bits of resolution (# Avgs=1)
≤ 2 us/div	200 ns/div	8
5 us/div	1 us/div	9
20 us/div	5 us/div	10
100 us/div	20 us/div	11
500 us/div	100 us/div	12

Realtime Mode

In Realtime mode, the oscilloscope produces the waveform display from samples collected during one trigger event. The sample rate for the 54620-series is 200 MSa/s for single channel or 100 MSa/s with channel pairs 1 and 2, 3 and 4, or pod 1 and pod 2 running. The sample rate for the 54640-series is 2 GSa/s for single channel or 1 GSa/s with channel pairs 1 and 2, or pod 1 and pod 2 running.

When less than 1000 samples can be collected in the time spanned by the screen, a sophisticated reconstruction filter is used to fill in and enhance the waveform display.

To accurately reproduce a sampled waveform, the sample rate should be at least four times the highest frequency component of the waveform. If not, it is possible for the reconstructed waveform to be distorted or aliased. Aliasing is most commonly seen as jitter on fast edges.

When Realtime mode is off, the oscilloscope produces the waveform display from samples collected from multiple triggers, when on fast sweep speeds. In this case, the reconstruction filter is not used. When the trigger is stable, this produces the highest fidelity waveform.

Realtime mode is only necessary at sweep speeds of 200 ns/div and faster for the 54620-series and 2 μ s/div and faster for the 54640-series, since on these ranges <1000 samples can be collected on each trigger. While the effective bandwidth of the channel is reduced slightly, Realtime mode produces a complete waveform for each trigger.

Realtime can be turned on when any other acquisition mode is turned on. Use Realtime to capture infrequent triggers, unstable triggers, or complex changing waveforms, such as eye diagrams.

Display modes

- Press the **Display** key to view the Display menu.



Infinite Persistence

Infinite persistence (**∞ Persist** softkey) updates the display with new acquisitions but does not erase previous acquisitions. New sample points are shown at normal intensity while previous acquisitions are displayed in minimum intensity. Waveform persistence is not kept beyond the display area boundary. Use infinite persistence to measure noise and jitter, to see the worst-case extremes of varying waveforms, to look for timing violations, or to find infrequent events.

Press the **Clear Display** softkey to erase previously acquired points. The display will again accumulate points until **Clear Display** is pressed or infinite persistence is turned off.

More information on infinite persistence applications is given in the “Run/Stop/Single/Infinite Persistence/Clear Operation” topic later in this chapter.

Clear display

Clear Display erases the display of all previous acquisitions and erases any traces recalled from the oscilloscope internal memory or from floppy disk. The internal memory will still retain the traces.

If the oscilloscope is running, the display will again begin to accumulate waveform data if infinite persistence is turned on.

Grid

The intensity of the 8 x 10-division display grid can be set from 0% (off) to 100% (full brightness) by turning the Entry knob. The value of grid intensity is displayed in the **Grid** softkey.

To adjust waveform intensity, turn the INTENSITY knob in the lower-left corner of the front-panel.

Display modes

Vectors On/Off

The 54620/40-series oscilloscopes have been designed from the ground up to operate in Vectors On mode. This mode gives the most realistic waveforms in most every situation.

When enabled, **Vectors** draws a line between consecutive waveform data points.

- Vectors give an analog look to a digitized waveform.
- Vectors allow you to see steep edges on waveforms, such as square waves.
- Vectors on allows subtle detail of complex waveforms to be viewed, much like an analog scope trace, even when the detail is just a small number of pixels in size.

Turn vectors off to prevent misconnections at fast sweep speeds (< 200 ns/div for 54620-series and <50 ns/div for 54640-series) when viewing changing waveforms, such as eye diagrams. Consider using Realtime acquire mode for these signals also.

Turn vectors off to remove any interpolation artifacts of Single or Realtime acquire modes. Vectors off mode displays only actual A/D samples.

You can turn vectors on and off, or switch from peak detect to normal acquire modes after you acquire data. If you acquire data in Normal mode, then switch to peak detect, you will see all the peaks in memory. You are not guaranteed, however, of seeing every peak.

Digital channels on the mixed-signal oscilloscope are not affected by the Display menu. They are always displayed with peak detect and vectors on. They also only contain one trigger worth of information.

Pan and Zoom

The ability to pan (move horizontally) and zoom (expand or compress horizontally) an acquired waveform is important because of the additional insight it can reveal about the captured waveform. This additional insight is often gained from seeing the waveform at different levels of abstraction. You may want to view both the big picture and the specific little picture details.

The ability to examine waveform detail after the waveform has been acquired is a benefit generally associated with digital oscilloscopes. Often this is simply the ability to freeze the display for the purpose of measuring with cursors or printing the screen. Some digital oscilloscopes go one step further by including the ability to further examine the signal details after acquiring them by panning and zooming through the waveform.

There is no limit imposed on the zoom ratio between the sweep speed used to acquire the data and the sweep speed used to view the data. There is, however, a useful limit. This useful limit is somewhat a function of the signal you are analyzing.

In normal display mode, with vectors (connect-the-dots) off, you can zoom in to the point where there are no samples on the screen. Obviously, this is far beyond the useful limit. Likewise, with vectors on, you can see the linear interpolation between the points, but again, this is of very limited value.

Zoom

The screen will still contain a relatively good display if you zoom in horizontally by a factor of 1000 and zoom in vertically by a factor of 10 to display the information from where it was acquired. Remember that you can only make automatic measurements on displayed data.

To pan and zoom a waveform

To pan and zoom a waveform

- 1 Press the **Run/Stop** key to stop acquisitions. The **Run/Stop** key is illuminated red when the oscilloscope is stopped.
- 2 Turn the sweep speed knob to zoom horizontally and turn the volts/division knob to zoom vertically.
The ∇ symbol at the top of the display indicates the time reference point where the zoom-in/zoom-out is referenced.
- 3 Turn the Delay time knob ($\blacktriangleleft\blacktriangleright$) to pan horizontally and turn the channel position knob (\blacklozenge) to pan vertically.

Run/Stop/Single/Infinite Persistence Operation

During an acquisition, the oscilloscope examines the input voltage at each input probe.

- For analog channels, the input voltage is determined by the vertical volts/division settings.
- For digital channels, at each sample the oscilloscope compares the input voltage to the logic threshold. If the voltage is above the threshold, the oscilloscope stores a 1 in sample memory; otherwise, it stores a 0.

To control the acquisition process, you can do the following:

- Perform continuous acquisitions by pressing **Run/Stop** (key is illuminated green), and stop the acquisitions by pressing **Run/Stop** again (key is illuminated red).
- Take exactly one acquisition, then stop by pressing the **Single** key.
- Store the results of several acquisitions by using infinite persistence when the scope is running.
- Erase the results of all acquisitions by pressing **Clear Display** in the Display menu.

Acquiring Data

The oscilloscope operates like an analog oscilloscope, but it can do much more. Spending a few minutes to learn some of this capability will take you a long way toward more productive troubleshooting.

Single versus Run/Stop

The oscilloscope has a **Single** key and a **Run/Stop** key. When you press **Run/Stop** (key is illuminated green when running), the trigger processing rate is optimized over memory depth. Single always uses the maximum memory available. When you press the **Single** key, the oscilloscope has at least twice as much memory as when running repetitively. Because more memory is available when using Single at slow sweep speeds, the oscilloscope will have a greater sample rate.

When the oscilloscope is running, pressing **Run/Stop** (key is illuminated red when stopped), the oscilloscope stops, and several triggers of information could be displayed on the screen. This will happen in several cases:

- At very fast sweep speeds (2 $\mu\text{s}/\text{div}$ and faster), you might see less than a full screen of data per trigger. In this case, we build a picture from several triggers. Doing this provides a more accurate and responsive display than mathematically interpolating between points.
- With **Average** acquire mode on, several triggers are averaged together to reduce noise.
- When using infinite persistence, all triggers remain on the screen.
- At very slow sweep speeds (1 s/div), part of the last trigger may still be on the screen when the oscilloscope is stopped.

Memory Depth/Record Length

Run/Stop versus Single

When the oscilloscope is running, the trigger processing or update rate is optimized over memory depth. When you press **Single**, memory depth and sample rate are maximized.

Single

For a single acquisition, all available memory is filled with each acquisition, regardless of sweep speed. To acquire data with the longest possible record length, press the **Single** key.

Running

When running, versus taking a single acquisition, the memory is divided in half. This allows the acquisition system to acquire one record while processing the previous acquisition, dramatically improving the number of waveforms per second processed by the oscilloscope. While running, maximizing the rate at which waveforms are drawn on the display provides the best picture of your input signal.

To run and stop an acquisition

To run and stop an acquisition

- To begin an acquisition, press **Run/Stop** (key is illuminated green when running).

The instrument begins acquiring data while searching for a trigger condition. If a trigger occurs, the acquired data is shown in the display.

- To stop an acquisition in process, press **Run/Stop** (key is illuminated red when stopped).

The instrument stops acquiring data and **STOP** is displayed in the trigger mode position of the status line in the upper-right corner of the display. If the instrument was triggered (even by auto triggering) and the pre-trigger and post-trigger buffers are full, the results are displayed on the screen. If the buffers are not full (that is, no triggers occurred), the waveform display area will show nothing.

To take a single trace

- Press the **Single** key.

The **Single** key will illuminate. The oscilloscope starts the acquisition system and begins searching for the trigger condition.

When the oscilloscope is in infinite persistence display mode (see “To use Infinite Persistence” topic) pressing **Single** erases the results of previous acquisitions from the current display contents.

Auto Single

Auto-trigger will generate a trigger for you if one is not found in the predetermined time from when the trigger system is armed. To take a single-shot acquisition, and you are not particularly interested in triggering the acquisition (for example, if you are probing a DC level), set Trigger Mode/Coupling mode to Auto and press the **Single** key. If a trigger exists, it will be used; if a trigger does not exist, an untriggered acquisition will be taken.

To capture a single event

To capture a single event, you need some previous knowledge of the signal to set up the trigger level and slope. For example, if the event is derived from TTL logic, a trigger level of 2 volts should work on a rising edge. These steps show you how to use the oscilloscope to capture a single event.

- 1 Connect a signal to the oscilloscope.
- 2 Set up the trigger.
 - a Define an edge, pulse width, pattern, or other advanced trigger type.
 - b Press the **Mode/Coupling** key and set trigger **Mode** to **Normal**.
 - c If you are using the analog channels to capture the event, turn the trigger Trigger Level knob to the trigger threshold where you think the trigger should work.
- 3 Press the **Single** key.

Pressing the **Single** key arms the trigger circuit and the **Single** key will be illuminated. When the trigger conditions are met, data appears on the display, representing the data points that the oscilloscope obtained with one acquisition and the **Run/Stop** key will be illuminated red. Pressing the **Single** key again re-arms the trigger circuit and erases the display.

Operating Hints

When Trigger Mode is set to Auto or AutoLvl (auto-single mode), each time **Single** is pressed the oscilloscope will wait for a valid trigger. If no trigger is found after about 40 ms, the oscilloscope will force a trigger, acquiring whatever signal is present. This is a handy mode to look for totally unknown situations.

When Trigger mode set to Normal, pressing **Single** will arm the trigger circuit and do a single acquisition when a valid trigger is seen.

You can use recalled traces to compare several single-shot events. See the "Saving and Recalling Traces and Setups" section later in this chapter.

To use infinite persistence

With infinite persistence, the oscilloscope updates the display with new acquisitions, but does not erase the results of previous acquisitions. Rather than being erased by subsequent acquisitions, the previous acquisition is displayed in minimum intensity. Thus, the results of all previous acquisitions are displayed in minimum intensity, with the latest acquisition in normal intensity.

Infinite persistence is useful in a number of applications, including:

- Display the worst-case extremes of varying waveforms.
 - Capture and store waveforms.
 - Measure noise and jitter.
 - Capture events that occur infrequently.
-

To use infinite persistence to store multiple repetitive events

- 1 Connect a signal to the oscilloscope.
- 2 Press the **Display** key, then press **∞ Persist** to turn on infinite persistence.
The display will begin accumulating multiple acquisitions. Previous acquisitions will be displayed in minimum intensity.
- 3 Press the **Clear Display** softkey to erase previous acquisitions.
The oscilloscope will again start to accumulate acquisitions.
- 4 Turn off infinite persistence, then press the **Clear Display** key to return the oscilloscope to the normal display mode.

Clearing stored infinite persistence waveforms

In addition to clearing the display by pressing the **Clear Display** softkey, the display is also cleared of previous acquisitions any time you make a setting that will change the display, including changing sweep speed, volts/division, delay time, or channel position controls.

To clear the waveform display

- Press the **Display** key, then press the **Clear Display** softkey.
Acquisition memory and the current display are immediately erased. If the instrument is running, however, and the oscilloscope finds a trigger condition, the display will be quickly updated after the erasure.

Summary of oscilloscope Run Control and infinite persistence keys

Run/Stop illuminated green—acquires data and displays the most recent trace.

Run/Stop illuminated red—freezes the display.

Single—acquires a single trace.

∞ Persist—infinite persistence acquires data, displaying the most recent trace in full-bright and previously acquired waveforms in half-bright.

Clear Display—clears the display.

Configuring the Mixed-Signal Oscilloscope

This section describes how to configure the following items for the Mixed-Signal Oscilloscope, including changing the logic threshold for input signals.

To display digital channels using Autoscale

When signals are connected to the digital channels, Autoscale quickly configures and displays the digital channels.

- To configure the instrument quickly, press the **Autoscale** key.
Any digital channel with an active signal will be displayed. Any digital channels without active signals will be turned off.
- To undo the effects of Autoscale, press the **Undo Autoscale** softkey before pressing any other key.
- To set the instrument to the factory-default configuration, press the **Save/Recall** key, then press the **Default Setup** softkey.

Interpreting the digital waveform display

The following figure shows a typical display with digital channels.

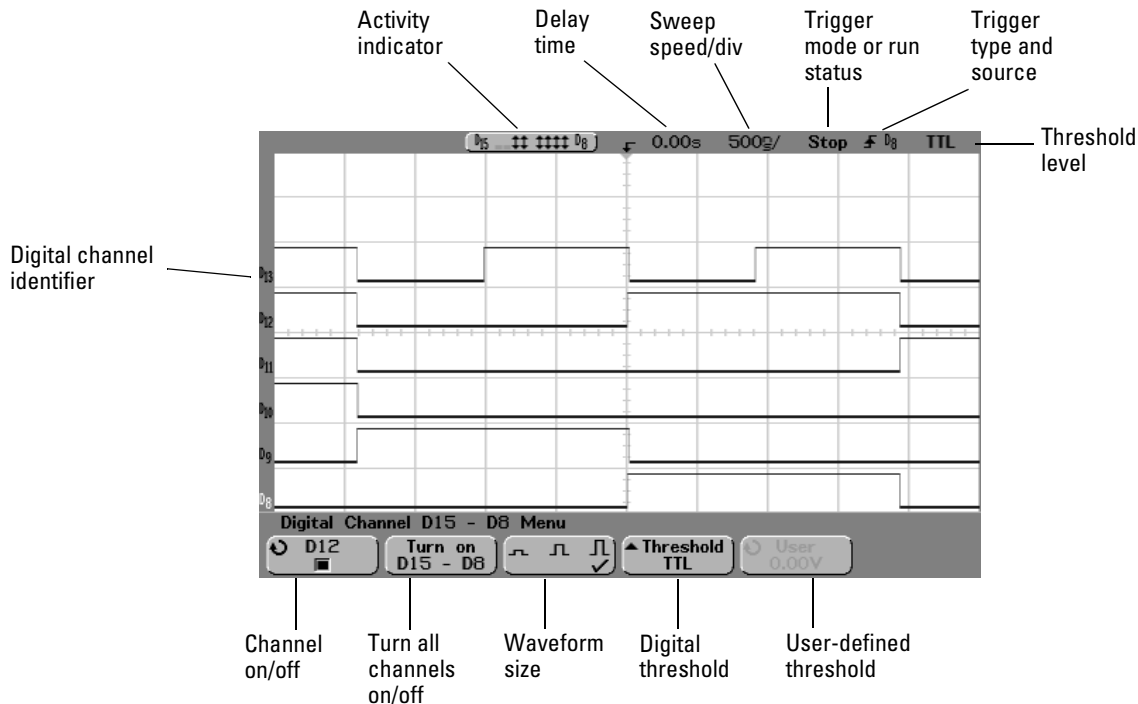

Activity indicator

When any digital channels are turned on, an activity indicator is displayed in the status line at the top of the display. A digital channel can be always high (■), always low (■), or actively toggling logic states (↕). Any channel that is turned off will be grayed out in the activity indicator.

To display and rearrange the digital channels

- 1 Press the **D15 Thru D8** key or **D7 Thru D0** key to turn the display of the digital channels on or off.

Digital channels are displayed when the **D15 Thru D8** or **D7 Thru D0** key is illuminated.

- 2 Turn the Digital Channel Select knob to select a digital channel.

As you turn the Channel Select knob, the selected channel number is highlighted on the left side of the display.

- 3 Turn the Digital position knob to reposition the selected channel on the display.

If two or more channels are displayed at the same vertical position, the channel number will be shown as **D*** on the left side of the display. When you use the Channel Select knob to select this channel, a pop up will appear showing the list of overlaid channels. Continue turning the Channel Select knob until the desired channel within the pop up is selected. You can also use this feature to bus several signals together on the display.

List of stacked channels

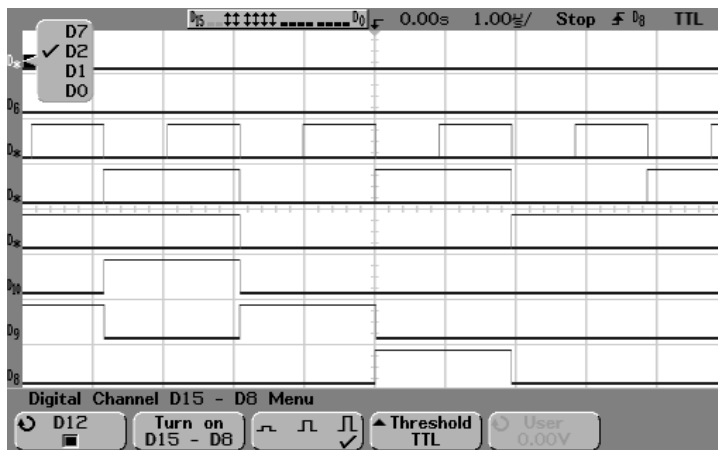

To turn individual channels on and off

Individual channels within the pod group can be turned on or off.

- 1 Press the **D15 Thru D8** key or **D7 Thru D0** key.
- 2 Turn the Entry knob to select a digital channel to turn on or off.
If the **User** threshold softkey was previously selected, make sure you press the digital channel on/off softkey to assign it to the Entry knob.

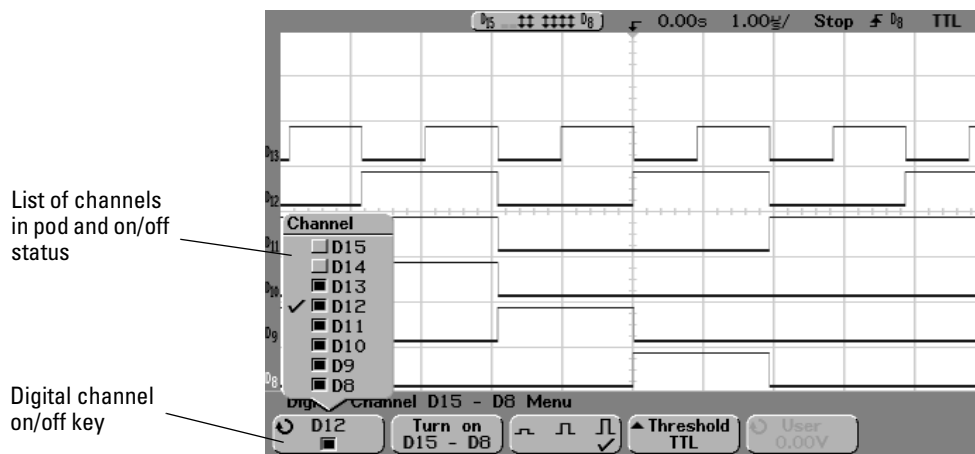

- 3 After you have selected the channel, press the channel on/off key to turn the channel on or off.
When the channel is on, the box in the channel on/off softkey is filled (■); when channel is off, the box is not filled (□).

To force all channels on or all channels off

- 1 Press the **D15 Thru D8** key or **D7 Thru D0** key.
- 2 Press the **Turn on** (or **Turn off**) softkey.



Each time you press this softkey, the softkey toggles between **Turn on** and **Turn off**. When pressed, this softkey forces all digital channels in the selected pod to be turned on or to be turned off.

To turn one or more of the individual channels back off or on, turn the Entry knob to select the desired channel, then press the channel on/off softkey to turn the channel on or off.

Turn on/Turn off softkey and D15 Thru D8/D7 Thru D0 key differences

The **Turn on/Turn off** softkey toggles the on/off state of the channels. The **D15 Thru D8/D7 Thru D0** front-panel key toggles the display state of the channels. Toggling the display state means you can setup what channels you want to see, then quickly hide or display the channels by pressing the **D15 Thru D8/D7 Thru D0** key.

To change the display size of the digital channels

- 1 Press the **D15 Thru D8** key or **D7 Thru D0** key.
- 2 Press the size (  ) softkey to select how the digital channels are displayed.

The sizing control allows you to spread out or compress the digital traces vertically on the display for more convenient viewing. Setting the size in either digital channel menu determines the size for all displayed digital channels.

Select  to display 8 channels or  to display 16 channels full screen.

Select  to display 16 channels in half of the display.

To change the logic threshold for digital channels

- 1 Press the **D15 Thru D8** key or **D7 Thru D0** key.
- 2 Press the **Threshold** softkey, then select a logic family preset or select **User** to define your own threshold.

Logic family	Threshold Voltage
TTL	1.4 V
CMOS	2.5 V
ECL	-1.3 V
User	Variable from -8 V to +8 V

The threshold you set applies to all channels within the selected **D15 Thru D8** or **D7 Thru D0** group. Each of the two channel groups can be set to a different threshold, if desired.

Values greater than the set threshold are high (H) and values less than the set threshold are low (L).

- 3 When the **Threshold** softkey is set to **User**, press the **User** softkey, then turn the **Entry** knob to set the logic threshold voltage for the channel group.

Using Digital Channels to Probe Circuits

You may encounter problems when using the mixed-signal oscilloscope that are related to probing. These problems fall into two categories: probe loading and probe grounding. Probe loading problems generally affect the circuit under test, while probe grounding problems affect the accuracy of the data to the measurement instrument. The design of the probes minimizes the first problem, while the second is easily addressed by good probing practices.

Input Impedance

The logic probes are passive probes, which offer high input impedance and high bandwidths. They usually provide some attenuation of the signal to the oscilloscope, typically 20 dB.

Passive probe input impedance is generally specified in terms of a parallel capacitance and resistance. The resistance is the sum of the tip resistor value and the input resistance of the test instrument (see the following figure). The capacitance is the series combination of the tip compensating capacitor and the cable, plus instrument capacitance in parallel with the stray tip capacitance to ground. While this results in an input impedance specification that is an accurate model for DC and low frequencies, the high-frequency model of the probe input is more useful (see the following figure). This high-frequency model takes into account pure tip capacitance to ground as well as series tip resistance, and the cable's characteristic impedance (Z_0).

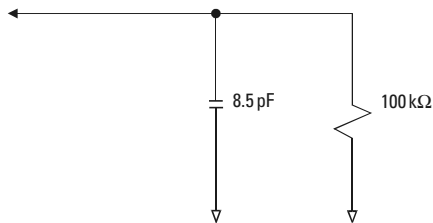

DC and Low-Frequency Probe Equivalent Circuit

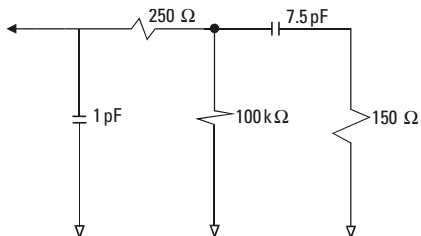

High-Frequency Probe Equivalent Circuit

The impedance plots for the two models are shown in these figures. By comparing the two plots, you can see that both the series tip resistor and the cable's characteristic impedance extend the input impedance significantly. The stray tip capacitance, which is generally small (1 pF), sets the final break point on the impedance chart.

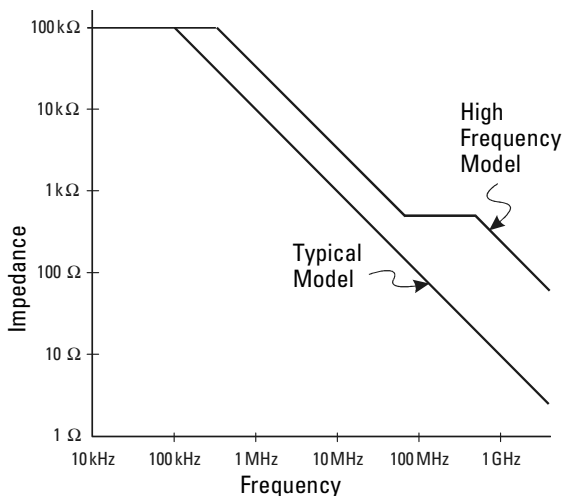

Impedance versus Frequency for Both Probe Circuit Models

The logic probes are represented by the high-frequency circuit model shown above. They are designed to provide as much series tip resistance as possible. Stray tip capacitance to ground is minimized by the proper mechanical design of the probe tip assembly. This provides the maximum input impedance at high frequencies.

MegaZoom Concepts and Oscilloscope Operation

Using Digital Channels to Probe Circuits

Probe Grounding

A probe ground is the low-impedance path for current to return to the source from the probe. Increased length in this path will, at high frequencies, create large common mode voltages at the probe input. The voltage generated behaves as if this path were an inductor according to the equation:

$$V = L \frac{di}{dt}$$

Increasing the ground inductance (L), increasing the current (di) or decreasing the transition time (dt), will all result in increasing the voltage (V). When this voltage exceeds the threshold voltage defined in the oscilloscope, a false data measurement will occur.

Sharing one probe ground with many probes forces all the current that flows into each probe to return through the same common ground inductance of the probe whose ground return is used. The result is increased current (di) in the above equation, and, depending on the transition time (dt), the common mode voltage may increase to a level that causes false data generation.

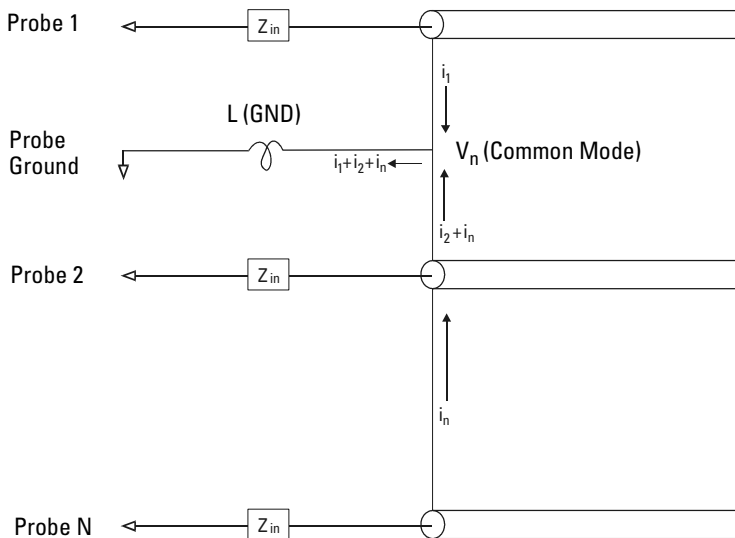

Common Mode Input Voltage Model

In addition to the common mode voltage, longer ground returns also degrade the pulse fidelity of the probe system. Rise time is increased, and ringing, due to the undamped LC circuit at the input of the probe, is also increased. Because the digital channels display reconstructed waveforms, they do not show ringing and perturbations. You will not find ground problems through examination of the waveform display. In fact, it is likely you will discover the problem through random glitches or inconsistent data measurements. Use the analog channels to view ringing and perturbations.

Best Probing Practices

Because of the variables L , di , and dt , you may be unsure how much margin is available in your measurement setup. The following are guidelines for good probing practices:

- The ground lead from each digital channel group (D15–D8 and D7–D0) should be attached to the ground of the circuit under test if any channel within the group is being used for data capture.
- When capturing data in a noisy environment, every third digital channel probe's ground should be used in addition to the channel group's ground.
- High-speed timing measurements (rise time < 3 ns) should make use of each digital channel probe's own ground.

When designing a high-speed digital system, you should consider designing dedicated test ports that interface directly to the instrument's probe system. This will ease measurement setup and ensure a repeatable method for obtaining test data. The 01650-61607 16-channel logic probe and termination adapter is designed to make it easy to connect to industry-standard, 20-pin board connectors. This probe consists of a 2 m logic analyzer probe cable and a 01650-63203 termination adapter that provides the proper RC networks in a very convenient package. Three 20-pin, low-profile, straight board connectors are included. Additional board connectors can be ordered from Agilent Technologies.

Using Labels on the Mixed-Signal Oscilloscope

The Mixed-Signal Oscilloscopes allow you to define and assign labels to each input channel, or you can turn labels off to increase the waveform display area.

To turn the label display on or off

- 1 Press the **Label** key in the Digital section of the front panel.

This turns on display labels for the analog and digital channels. When the **Label** key is illuminated, the labels for displayed channels are displayed on the left side of the displayed traces. When labels are on, the label is also displayed in softkeys for the selected channel or source. The figure below shows an example of the default labels assigned when you turn the label display on. The channel labels default to their channel number.

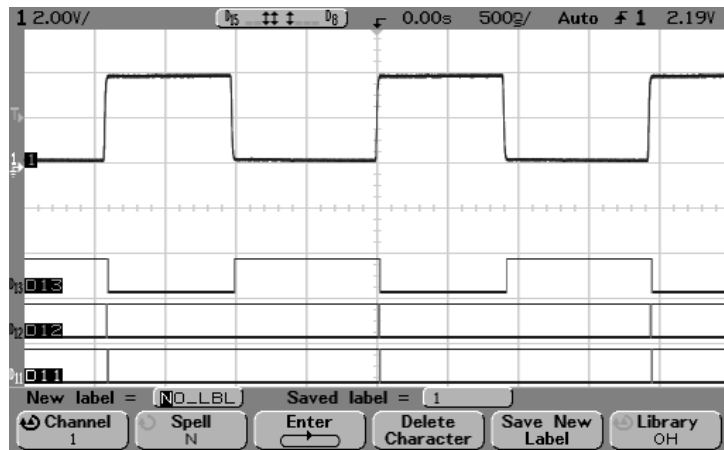

- 2 To turn the labels off, press the **Label** key until it is not illuminated.

To assign a predefined label to a channel**To assign a predefined label to a channel**

- 1 Press the **Label** key.
- 2 Press the **Channel** softkey, then turn the Entry knob or successively press the softkey to select a channel for label assignment.

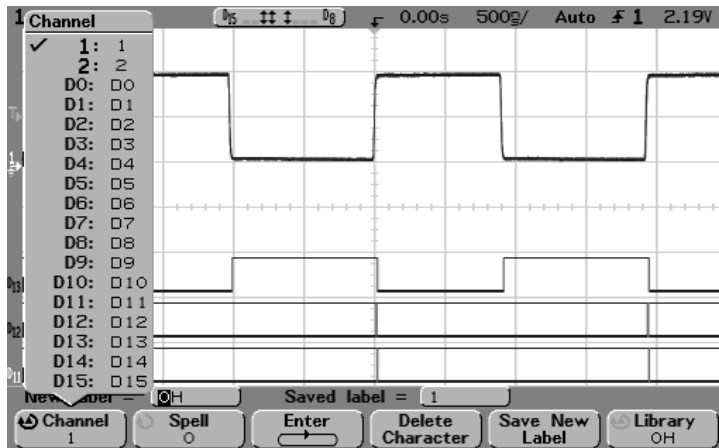

The figure above shows the list of channels and their default labels. The channel does not have to be turned on to have a label assigned to it.

- 3 Press the **Library** softkey, then turn the Entry knob or successively press the **Library** softkey to select a predefined label from the library.
- 4 Press the **Save New Label** softkey to assign the label to your selected channel.
- 5 Repeat the above procedure for each predefined label you want to assign to a channel.

To define a new label

- 1 Press the **Label** key.
- 2 Press the **Channel** softkey, then turn the Entry knob or successively press the softkey to select a channel for label assignment.
The channel does not have to be turned on to have a label assigned to it.
- 3 Press the **Spell** softkey, then turn the Entry knob to select the first character in the new label.
Turning the Entry knob selects a character to enter into the highlighted position shown in the "**New label =**" line above the softkeys and in the **Spell** softkey. Labels can be up to six characters in length.
- 4 Press the **Enter** softkey to enter the selected character and to go to the next character position.
You may position the highlight on any character in the label name by successively pressing the **Enter** softkey.
- 5 To delete a character from the label, press the **Enter** softkey until the letter you want to delete is highlighted, then press the **Delete Character** softkey.
- 6 When you are done entering characters for the label, press the **Save New Label** softkey to assign the label to the selected channel.
When you define a new label, it is added to the non-volatile label list.

Label Assignment Auto-Increment Features

When you assign a label ending in a digit, such as ADDR0 or DATA0, the oscilloscope automatically increments the digit and displays the modified label in the "New label" field after you press the **Save New Label** softkey. Therefore, you only need to select a new channel and press the **Save New Label** softkey again to assign the label to the channel. Only the original label is saved in the label list. This feature makes it easier to assign successive labels to numbered control lines and data bus lines.

To define a new label

Label List Management

When you press the **Library** softkey, you will see a list of the last 75 labels used. The list does not save duplicate labels. Labels can end in any number of trailing digits. As long as the base string is the same as an existing label in the library, the new label will not be put in the library. For example, if label A0 is in the library and you make a new label called A12345, the new label is not added to the library.

When you save a new user-defined label, the new label will replace the oldest label in the list. Oldest is defined as the longest time since the label was last assigned to a channel. Any time you assign any label to a channel, that label will move to the newest in the list. Thus, after you use the label list for a while, your labels will predominate, making it easier to customize the instrument display for your needs.

When you reset the label library list (see next topic), all of your custom labels will be deleted, and the label list will be returned to its factory configuration.

To reset the label library to the factory default

- 1 Press the **Utility** key, then press the **Options** softkey.

CAUTION

Pressing the Default Library softkey will remove all user-defined labels from the library and set the labels back to the factory default. Once deleted, these user-defined labels cannot be recovered.

- 2 Press the **Default Library** softkey.

This will delete all user-defined labels from the library and set the labels in the library back to the factory default. However, this does not default the labels currently assigned to the channels (those labels that appear in the waveform area).

Defaulting labels without erasing the default library.

Selecting **Default Setup** in the **Save/Recall** menu will set all channel labels back to the default labels (1, 2, D15-D0), but does not erase the list of user-defined labels in the Library.

Saving and Recalling Traces and Setups

You can save your current setup and waveform trace to the floppy disk or to internal memory, then recall the setup, waveform trace, or both later.

When you save a setup, all settings including measurements, cursors, math functions, and horizontal, vertical, and trigger settings are saved to the file you have selected.

Making a hardcopy print

To make a hardcopy of the complete screen image including the status line and softkeys, use the **Quick Print** key. Configure your printer in the **Utility -> Print Config** menu.

Saving a trace allows you to save the visible portion of the acquisition (the displayed waveform) for later recall and comparison with other measurements.

The normal application for a recalled trace is quick comparison of measurement results. For example, you might make a measurement on a known good system, save the result in internal trace memory or to floppy disk, then make the same measurement on a test system and recall trace to see the differences.

- Press the **Save/Recall** key to display the Save/Recall menu.



To Autosave traces and setups

- 1 Connect a signal to the oscilloscope and obtain a stable display.
- 2 Insert a disk in the oscilloscope floppy disk drive.
- 3 Press the **Press to Autosave** softkey.

Your current setup and waveform trace will be saved to an automatically generated file name (**QFILE_nn**) on the floppy disk. The file name is shown in the line above the softkeys. The **nn** number in the **QFILE_nn** file name will automatically increment (starting at **00**) each time you save a new file to floppy disk. Up to 100 traces and setups can be saved on each floppy disk if space permits.

When viewed from the floppy disk menu (front-panel **Utility** key) the trace file will have a **TRC** file extension and the setup file will have a **SCP** file extension. If you want to enter your own file name, overwrite an existing file name, or save to an internal oscilloscope memory, press the **Save** softkey to enter the Save menu.

To save traces and setups to internal memory or to overwrite an existing floppy disk file

To save traces and setups to internal memory or to overwrite an existing floppy disk file

- 1 Press the **Save** softkey to display the Save menu.



- 2 Press the **To:** softkey or turn the Entry knob to select a floppy disk file or internal memory to be overwritten.

INTERN_n (n is 0, 1, or 2 for 54620-series and 0, 1, 2, or 3 for 54640-series) file names are stored in internal non-volatile oscilloscope memory. **QFILE_nn** and any other user-defined files are stored on the floppy disk. Each time you select an internal memory or existing floppy disk file and save, the existing file will be overwritten.

- 3 When you have selected the file name to be overwritten, press the **Press to Save** softkey to save your current setup and waveform trace to the file.

The names of the three internal memory files cannot be changed. If you want to select a new file name, press the **New File** softkey.

To save traces and setups to a new file on the floppy disk

- 1 To create a new file name, press the **New File** softkey.

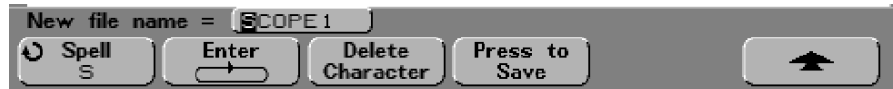

If you do not want to overwrite an existing file, use this menu to enter a new file name. New file names can be up to eight characters long. New file names can only be written to the floppy disk, not the internal memory.

- 2 Turn the Entry knob to select the first character in the file name.



Turning the Entry knob selects a character to enter into the highlighted position shown in the "New file name =" line above the softkeys and in the **Spell** softkey.

- 3 Press the **Enter** softkey to enter the selected character and go to the next character position.
You may position the highlight on any character in the file name by successively pressing the **Enter** softkey.
- 4 To delete a character from the file name, press the **Enter** softkey until the letter you want to delete is highlighted, then press the **Delete Character** softkey.
- 5 When you are done entering characters for the file name, press the **Press to Save** softkey to save the file.

Two files will be saved to the floppy disk. In the example above, **SCOPE1.TRC** will be the trace file and **SCOPE1.SCP** will be the setup file. You do not need to remember these file extensions because you can select trace, setup, or both when you recall this information using the Recall menu.

To recall traces and setups

To recall traces and setups

- 1 Press the **Save/Recall** key to display the Save/Recall menu.
- 2 Press the **Recall** softkey to display the Recall menu.



- 3 Press the **Recall** softkey and select the type of information to recall. You can recall a waveform **Trace**, an oscilloscope **Setup**, or **Trace and Setup**. Be sure to recall both setup and trace if you want to measure the recalled trace with cursors.
- 4 Select the file name to recall by turning the Entry knob while viewing the **From:** softkey.

INTERN_n are internal non-volatile oscilloscope memory files. All other files in the list are stored on the floppy disk.

Recalling overwrites current settings

Because recalling a setup will overwrite the oscilloscope's current settings, you may want to save the existing setup first.

- 5 Recall the selected file by pressing the **Press to Recall** softkey. The recalled trace will be displayed in minimum intensity.
- 6 To clear the display of any recalled trace, press the **Clear Display** softkey.

Saving (printing) screen images to floppy disk

- 1 Press the **Save/Recall** key to display the Save/Recall menu.
- 2 Press the **Formats** softkey to display the Formats menu.



The Formats menu allows you to quickly configure the **Quick Print** menu to save images to the floppy disk. Pressing one of the image format softkeys in this menu will link (**++>>>**) you to the **Utility -> Print Config** menu and allow you to send TIF, BMP, or CSV formatted data to the floppy disk.

To print a hardcopy of the screen image directly to a printer, configure the printer in the Utility -> Print Config menu, then press the **Quick Print** key.

- 3 Press the **CSV, TIF, or BMP** softkey.

You are linked to the **Utility -> Print Config** menu. The print configuration is automatically set to print to the floppy disk in the format you selected.

CSV data (comma-separated variable) are values of displayed channels and math waveforms suitable for spreadsheet analysis. You can also change the length of the CSV file when you are in the Print Config menu.

BMP and **TIF** data formats print the complete screen image, including the status line and softkeys. You can also choose to print oscilloscope Factors when you are in the Print Config menu.

- 4 Press the front-panel **Quick Print** key to start the transfer to the floppy disk.

For further information about setting up your printer, see the “Utility” chapter.

Recalling the factory default setup

- 1 Press the **Save/Recall** key to display the Save/Recall menu.
- 2 Press **Default Setup** softkey.

This returns the oscilloscope to its factory default settings and places the oscilloscope in a known operating condition. The major default settings are:

Horizontal main mode, 100 us/div scale, 0 s delay, center time reference

Vertical Channel 1 on, 5 V/div scale, dc coupling, 0 V position, probe factor to 1.0 if an AutoProbe probe is not connected to the channel

Trigger Edge trigger, Auto sweep mode, 0 V level, channel 1 source, dc coupling, rising edge slope, 60 ns holdoff time

Display Vectors on, 20% grid intensity, infinite persistence off

Other Acquire mode normal, Run/Stop to Run, cursor measurements off

Making Measurements

By now you are familiar with the Vertical/Analog, Horizontal, and Trigger groups of the front-panel keys. You should also know how to determine the setup of the oscilloscope by looking at the status line at the top of the display.

We recommend you perform all of the following exercises so you become familiar with the powerful measurement capabilities of the oscilloscope.

Concepts about the 54620/40-series Oscilloscopes

Conceptual information about the oscilloscopes is in the “MegaZoom Concepts and Oscilloscope Operation” chapter.

This chapter is organized into the following sections starting on these pages:

Capturing Data 5-3

Math Functions 5-17

Cursor Measurements 5-31

Automatic Measurements 5-37

Capturing Data

In the oscilloscope, an 8-bit A/D converter converts the input waveform into an evenly-spaced series of voltage readings. These readings are made once for each channel, and are stored into memory as an array of voltages with implicit times.

Main and Delayed Sweep

The delayed sweep display function magnifies the contents of sample memory—data used by the main and delayed sweep windows is acquired on a single acquisition; the data corresponds to the same trigger event. Using the delayed sweep window, you can zoom in on a portion of the waveform and examine it in greater detail.

The delayed sweep operation is based on MegaZoom technology. Unlike analog oscilloscopes, the MegaZoom oscilloscope's delayed sweep is not a second acquisition, but an expansion of the same data displayed in the main sweep. MegaZoom technology makes this possible because of its deep memory. It is possible to capture the main display at 1 ms/div, and redisplay the same trigger in the delayed display at 1 μ s/div—a 1000:1 zoom ratio.

When you enable the delayed sweep view, the oscilloscope divides the display into two portions. The upper part shows the waveform according to the main time base; the lower shows a small portion of the waveform magnified according to a second time base (the delayed sweep window). In the delayed sweep window, the horizontal time/division knob adjusts the magnification of the delayed sweep portion. The delayed sweep time base must be at least twice as fast as the main time base, and can vary up to the maximum sweep speed of 5 ns/div for 54620-series and 1 ns/div for 54640-series.

To use delayed sweep

You can use the delayed sweep window to locate and horizontally expand part of the main sweep for a more detailed (high-resolution) analysis of signals.

- 1 Connect a signal to the oscilloscope and obtain a stable display.
- 2 Press the **Main/Delayed** key.
- 3 Press the **Delayed** softkey.

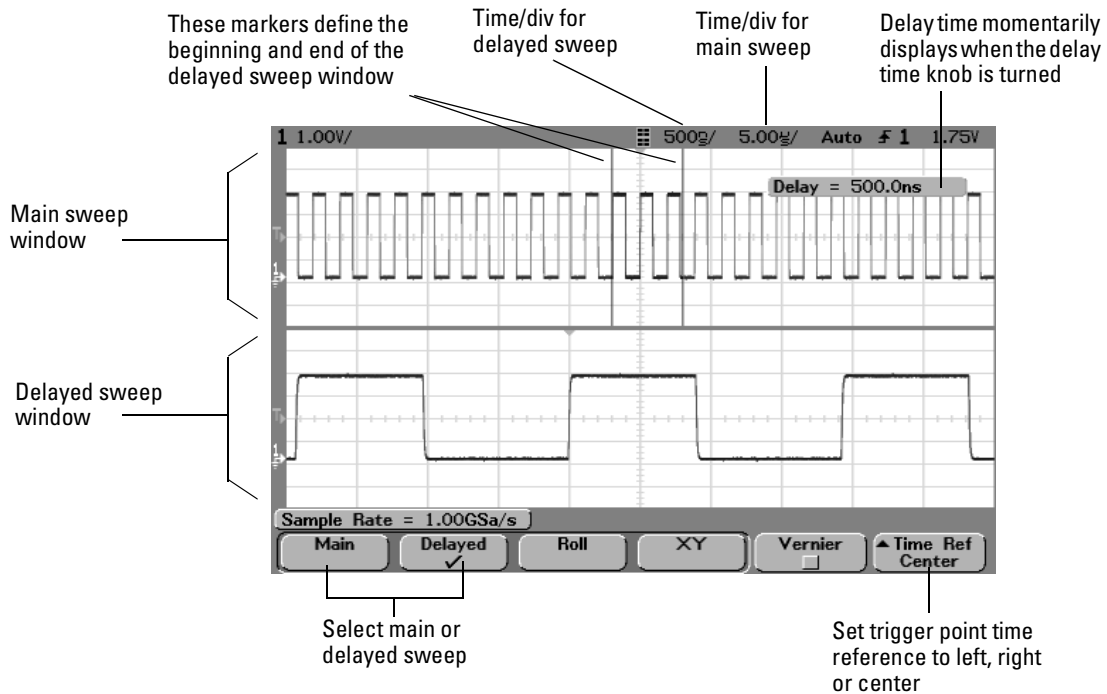

Delayed sweep display

Delayed sweep is an expanded version of main sweep. When Delayed mode is selected, the display divides in half and the delayed sweep  icon displays in the middle of the line at the top of the display. The top half displays the main sweep and the bottom half displays the delayed sweep.

4 Turn the horizontal sweep speed knob and delay time knob and note how the waveform expands, contracts, and moves on the display.

The area of the main display that is expanded is intensified and marked on each end with a vertical marker. These markers show what portion of the main sweep is expanded in the lower half. The Horizontal knobs control the size and position of the delayed sweep. The delay value is momentarily displayed in the upper-right portion of the display when the delay time (◀▶) knob is turned.

To change the sweep speed for the delayed sweep window, turn the sweep speed knob. As you turn the knob, the sweep speed is highlighted in the status line above the waveform display area.

To change the sweep speed for the main sweep window, press the **Main** softkey, then turn the sweep speed knob.

To reduce the random noise on a signal

If the signal you are applying to the oscilloscope is noisy, you can set up the oscilloscope to reduce the noise on the displayed waveform. First, you stabilize the displayed waveform by removing the noise from the trigger path. Second, you reduce the noise on the displayed waveform.

- 1 Connect a signal to the oscilloscope and obtain a stable display.
- 2 Remove the noise from the trigger path by turning on either high-frequency reject or noise reject.

High-frequency reject (HF reject) adds a low-pass filter with the 3-dB point at 50 kHz. You use HF reject to remove high-frequency noise, such as AM or FM broadcast stations, from the trigger path.

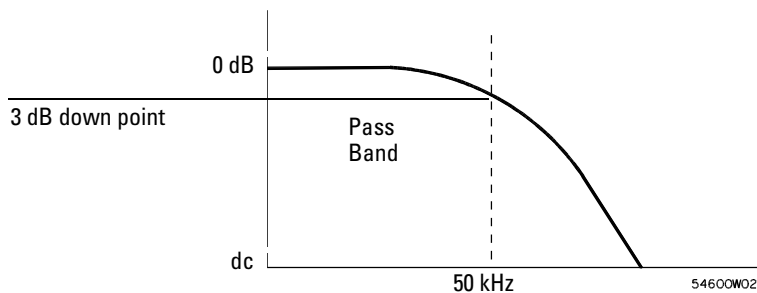

HF Reject

Low-frequency reject (LF reject) adds a high-pass filter with the 3-dB point at 50 kHz. Use LF reject to remove low-frequency signals, such as power line noise, from the trigger path.

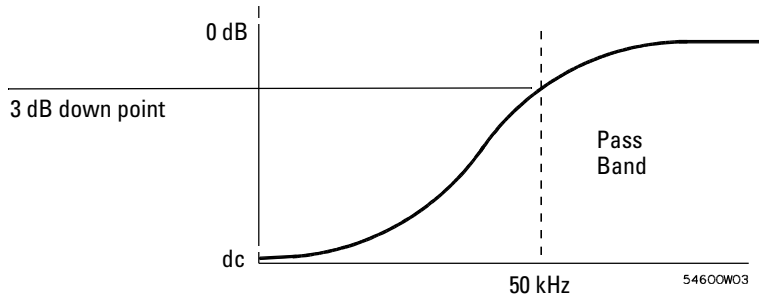

LF Reject

Noise reject increases the trigger hysteresis band. By increasing the trigger hysteresis band, you reduce the possibility of triggering on noise. However, this also decreases the trigger sensitivity so that a slightly larger signal is required to trigger the oscilloscope.

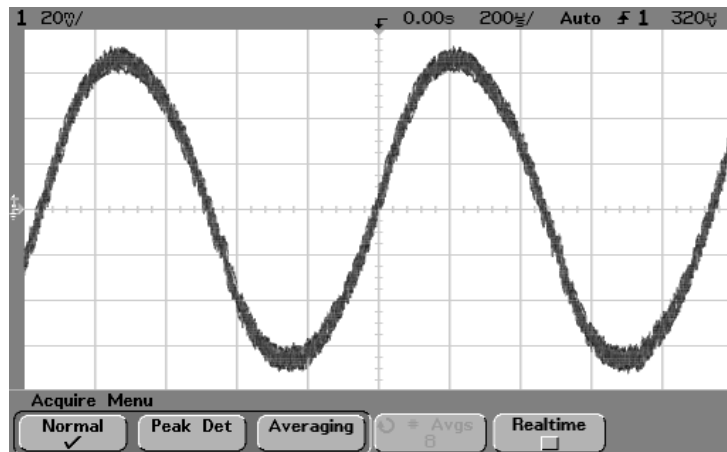

Random noise on the displayed waveform

To reduce the random noise on a signal

3 Use averaging to reduce noise on the displayed waveform.

- Press the **Acquire** key, then press the **Averaging** softkey.

Averaging lets you average multiple triggers together to reduce noise and increase resolution. Averaging of multiple triggers requires a stable trigger. The number of triggers being averaged is displayed in the **# Avgs** softkey.

- Turn the Entry knob to set the number of averages (**# Avgs**) that best eliminates the noise from the displayed waveform.

The number of averages can be set from 1 to 16383 in increments of powers of 2. The higher the number of averages you set, the more noise reduction and resolution that will be accomplished.

# Avgs	Bits of resolution
1	8
4	9
16	10
64	11
256	12

When the number of averages is higher, more noise is removed from the display. However, the higher the number of averages, the slower the displayed waveform responds to waveform changes. You must compromise between how quickly the waveform responds to changes and how much you want to reduce the displayed noise on the signal.

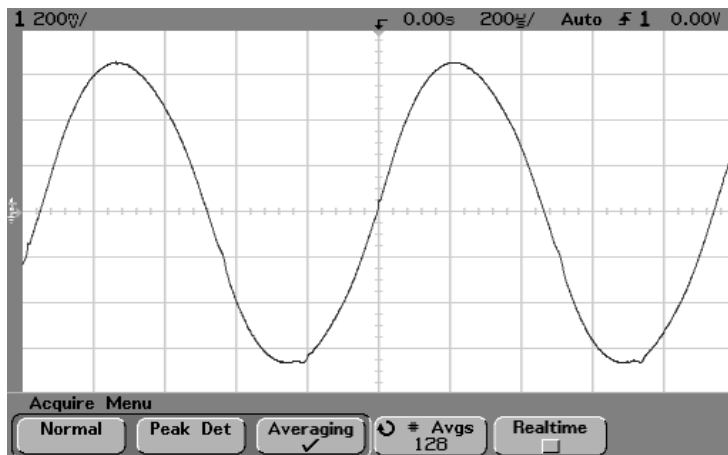

128 Averages used to reduce noise

High-resolution mode (# Avgs=1)

High-resolution mode is an oversampling technique used when the digitizer sampling rate is faster than the rate at that samples are being stored into acquisition memory. The sample rate for the 54620-series is 200 MSa/s for single channel or 100 MSa/s with channel pairs 1 and 2, 3 and 4, or pod 1 and pod 2 running. The sample rate for the 54640-series is 2 GSa/s for single channel or 1 GSa/s with channel pairs 1 and 2

For example, if the scope is sampling at 200 MSa/s, yet storing the samples at 1 MSa/s, it needs to store only 1 out of every 200 samples. When high-resolution mode is used, the slower the sweep speed, the greater the number of samples that are averaged together for each display point. This tends to reduce random noise on the input signal, which produces a smoother trace on the screen.

If you cannot acquire multiple triggers, you can still reduce noise and increase resolution at slower sweep speeds by setting **# Avgs** to 1.

54620-series Sweep speed	54640-series Sweep speed	Bits of resolution (# Avgs=1)
≤ 2 us/div	200 ns/div	8
5 us/div	1 us/div	9
20 us/div	5 us/div	10
100 us/div	20 us/div	11
500 us/div	100 us/div	12

To capture glitches or narrow pulses with peak detect and infinite persistence

A glitch is a rapid change in the waveform that is usually narrow as compared to the waveform. To capture glitches or narrow pulses:

- 1 Connect a signal to the oscilloscope and obtain a stable display.
- 2 To find the glitch, press the **Acquire** key, then, press the **Peak Det** softkey.

54620-series Peak detect acquire mode displays any signal pulse wider than 5 ns, allowing you to find glitches and narrow spikes regardless of sweep speed. Because of MegaZoom memory, peak detect is only necessary at sweep speeds of 1 ms/div and slower. At faster sweep speeds, Normal acquire mode can capture the narrow peaks.

At sweep speeds slower than 1 ms/div, the oscilloscope can acquire more samples than can fit into MegaZoom memory. The oscilloscope selects samples to store such that no local minimum or maximum wider than 5 ns is missed. In peak detect mode, narrow glitches and sharp edges are displayed more brightly than when in Normal acquire mode, making them easier to see.

54640-series Peak detect acquire mode displays any signal pulse wider than 1 ns, allowing you to find glitches and narrow spikes regardless of sweep speed. Because of MegaZoom memory, peak detect is only necessary at sweep speeds of 500 μ s/div and slower. At faster sweep speeds, Normal acquire mode can capture the narrow peaks.

At sweep speeds slower than 500 μ s/div, the oscilloscope can acquire more samples than can fit into MegaZoom memory. The oscilloscope selects samples to store such that no local minimum or maximum wider than 1 ns is missed. In peak detect mode, narrow glitches and sharp edges are displayed more brightly than when in Normal acquire mode, making them easier to see.

To capture glitches or narrow pulses with peak detect and infinite persistence**3 Press the **Display** key then press the ∞ **Persist** (infinite persistence) softkey.**

Infinite persistence updates the display with new acquisitions but does not erase previous acquisitions. New sample points are shown at normal intensity while previous acquisitions are displayed in minimum intensity. Waveform persistence is not kept beyond the display area boundary. Any time you change a waveform setting such as sweep speed, delay time, vertical sensitivity, or offset, the previous acquisitions will be erased, then begin to accumulate again.

Use infinite persistence to measure noise and jitter, to see the worst-case extremes of varying waveforms, to look for timing violations, or to find infrequent events.

Press the **Clear Display** softkey to erase previously acquired points. The display will again accumulate points until **Clear Display** is pressed or ∞ **Persist** is turned off.

4 Characterize the glitch with delayed sweep.

To characterize the glitch with delayed sweep, follow these steps:

- Press the **Main/Delayed** key, then press the **Delayed** softkey.
- To obtain a better resolution of the glitch, expand the time base.

Use the horizontal delay time knob ($\blacktriangleleft\blacktriangleright$) to pan through the waveform to set the expanded portion of the main sweep around the glitch.

To characterize the glitch, use the cursors or the automatic measurement capabilities of the oscilloscope.

To use the Roll horizontal mode

- Press the **Main/Delayed** key, then press the **Roll** softkey.

Roll mode causes the waveform to move slowly across the screen from right to left. It only operates on time base settings of 500 ms/div and slower. If the current time base setting is faster than the 500 ms/div limit, it will be set to 500 ms/div when Roll mode is entered.

In Normal horizontal mode, signal events occurring before the trigger are plotted to the left of the trigger point (▼) and signal events after the trigger plotted to the right of the trigger point.

In Roll mode there is no trigger. The fixed reference point on the screen is the right edge of the screen and refers to the current moment in time. Events that have occurred are scrolled to the left of the reference point. Since there is no trigger, no pretrigger information is available.

If you would like to clear the display and restart an acquisition in Roll mode, press the **Single** key.

Use Roll mode on low-frequency waveforms to give a display much like a strip chart recorder. It allows the waveform to roll across the display.

To use the XY horizontal mode

The XY horizontal mode converts the oscilloscope from a volts-versus-time display to a volts-versus-volts display using two input channels. Channel 1 is the X-axis input, channel 2 is the Y-axis input. You can use various transducers so the display could show strain versus displacement, flow versus pressure, volts versus current, or voltage versus frequency. This exercise shows a common use of the XY display mode by measuring the phase difference between two signals of the same frequency with the Lissajous method.

- 1 Connect a sine wave signal to channel 1, and a sine wave signal of the same frequency but out of phase to channel 2.
- 2 Press the **Autoscale** key, press the **Main/Delayed** key, then press the **XY** softkey.
- 3 Center the signal on the display with the channel 1 and 2 position (\blacklozenge) knobs. Use the channel 1 and 2 volts/div knobs and the channel 1 and 2 **Vernier** softkeys to expand the signal for convenient viewing.

The phase difference angle (θ) can be calculated using the following formula (assuming the amplitude is the same on both channels):

$$\sin \theta = \frac{A}{B} \text{ or } \frac{C}{D}$$

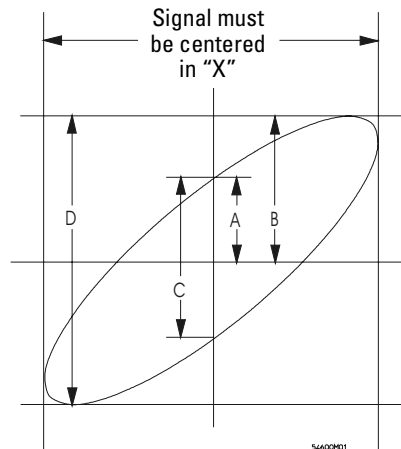

Example of centering a signal on the display

Making Measurements
To use the XY horizontal mode

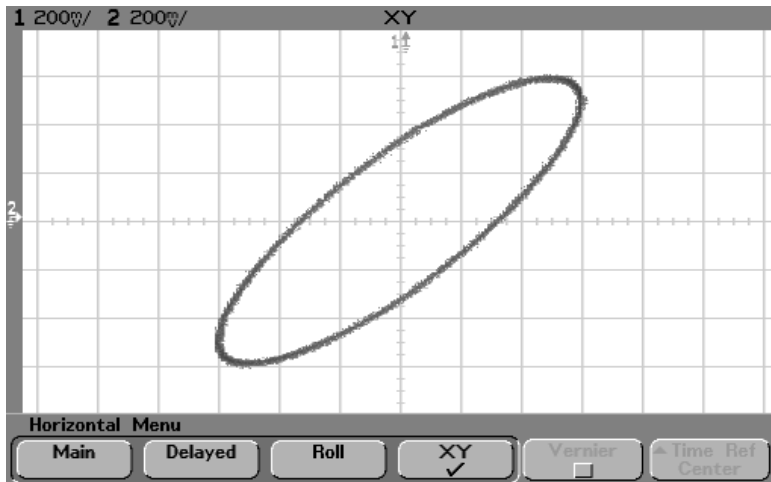

Signal centered on the display

- 4 Press the **Cursors** key.
- 5 Set the Y2 cursor to the top of the signal, and set Y1 to the bottom of the signal.

Note the ΔY value at the bottom of the display. In this example, we are using the Y cursors, but you could have used the X cursors instead.

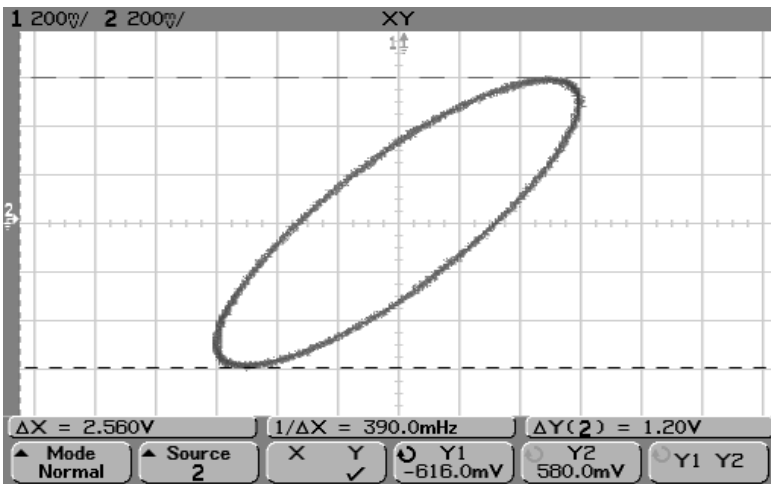

Cursors set on displayed signal

- 6 Move the Y1 and Y2 cursors to the intersection of the signal and the Y axis.
Again, note the ΔY value.

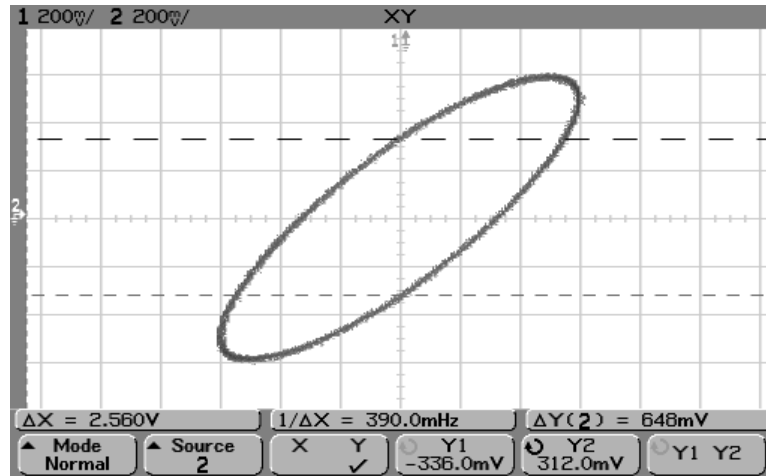

Cursors set to center of signal

- 7 Calculate the phase difference using the formula below.

$$\sin \theta = \frac{\text{second } \Delta Y}{\text{first } \Delta Y} = \frac{0.648}{1.20}; \theta = 32.68 \text{ degrees of phase shift}$$

XY Display Mode Operating Hint (Z-axis input on 54620-series only)

When you select the XY display mode, the time base is turned off. Channel 1 is the X-axis input, channel 2 is the Y-axis input, and the External trigger is the Z-axis input. If you only want to see portions of the Y versus X display, use the Z-axis input. Z-axis turns the trace on and off (analog oscilloscopes called this Z-axis blanking because it turned the beam on and off). When Z is low (<1.4 V), Y versus X is displayed; when Z is high (>1.4 V), the trace is turned off.

Making Measurements
To use the XY horizontal mode

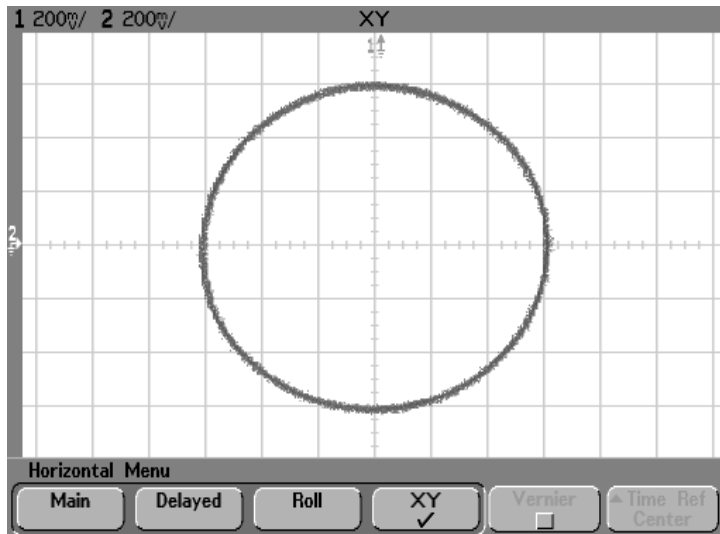

Signals are 90 out of phase

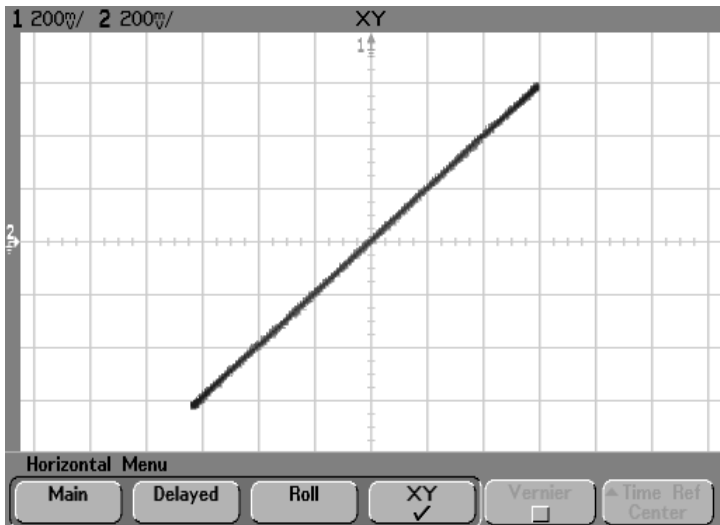

Signals are in phase

Math Functions

The Math menu allows you to display math functions on analog channels. You can:

- subtract (-) or multiply (*) the signals acquired on analog channels 1 and 2, then display the result.
- integrate, differentiate, or perform an FFT on the signal acquired on any analog channel or on math functions $1 * 2$, $1 - 2$, or $1 + 2$, then display the result.
- Press the **Math** key on the front panel to display the Math menu. After selecting a math function, press the **Settings** softkey to display settings for the selected math function if you want to change the Y scaling.



Math Operating Hints

- If the analog channel or math function is clipped (not fully displayed on screen,) the resulting displayed math function will also be clipped.
- Once the function is displayed, the analog channel(s) may be turned off for better viewing.
- The vertical scaling and offset of each math function can be adjusted for ease of viewing and measurement considerations.
- Each function can be measured in the **Cursors** and **Quick Meas** menus.

Math Scale and Offset

Any math function may be manually scaled by pressing the **Settings** softkey, and then adjusting the Scale or Offset value.

Math Scale and Offset are Set Automatically

Any time the currently displayed math function definition is changed, the function is automatically scaled for optimum vertical scale and offset. If you manually set scale and offset for a function, select a new function, then select the original function, the original function will be automatically rescaled.

- 1 Press the **Settings** softkey in the Math menu to set your own scale factors (units/division) or offset (units) for the selected math function.

Units for each input channel can be set to Volts or Amps using the channel **Probe Units** softkey. Scale and offset units are:

Math function	Units
FFT	dB* (decibels)
1*2	V ² , A ² , or W (Volt-Amp)
1-2	V or A
d/dt	V/s or A/s (V/second or A/second)
∫ dt	Vs or As (V-seconds or A-seconds)

* When the FFT source is channel 1 or channel 2 (or channel 3 or 4 on the 54624A), FFT units will be displayed in dBV when channel units is set to Volts and channel impedance is set to 1 MΩ. FFT units will be displayed in dBm when channel units is set to Volts and channel impedance is set to 50Ω (54640-series only). FFT units will be displayed as dB for all other FFT sources or when a source channel's units has been set to Amps.

A scale unit of **U** (undefined) will be displayed for math function 1-2 and for d/dt, and ∫ dt when 1-2 or 1+2 is the selected source if channel 1 and channel 2 are set to dissimilar units in the channel **Probe Units** softkey.

- 2 Press the **Scale** or **Offset** softkey, then turn the Entry knob to rescale or change the offset value for your math function.

Multiply

When you select **1 * 2**, channel 1 and channel 2 voltage values are multiplied point by point, and the result is displayed. **1 * 2** is useful for seeing power relationships when one of the channels is proportional to the current.

- Press the **Math** key, press the **1 * 2** softkey, then press the **Settings** softkey if you want to change the scaling or offset for the multiply function.

Scale allows you to set your own vertical scale factors for multiply expressed as V^2/div (Volts-squared/division), A^2/div (Amps-squared/division), or W/div (Watts/division or Volt-Amps/division). Units are set in the channel **Probe** menu. Press the **Scale** softkey, then turn the Entry knob to rescale **1 * 2**.

Offset allows you to set your own offset for the multiply math function. The offset value is in V^2 (Volts-squared), A^2 (Amps-squared), or W (Watts) and is represented by the center graticule of the display. Press the **Offset** softkey, then turn the Entry knob to change the offset for **1 * 2**.

The figure below shows an example of multiply.

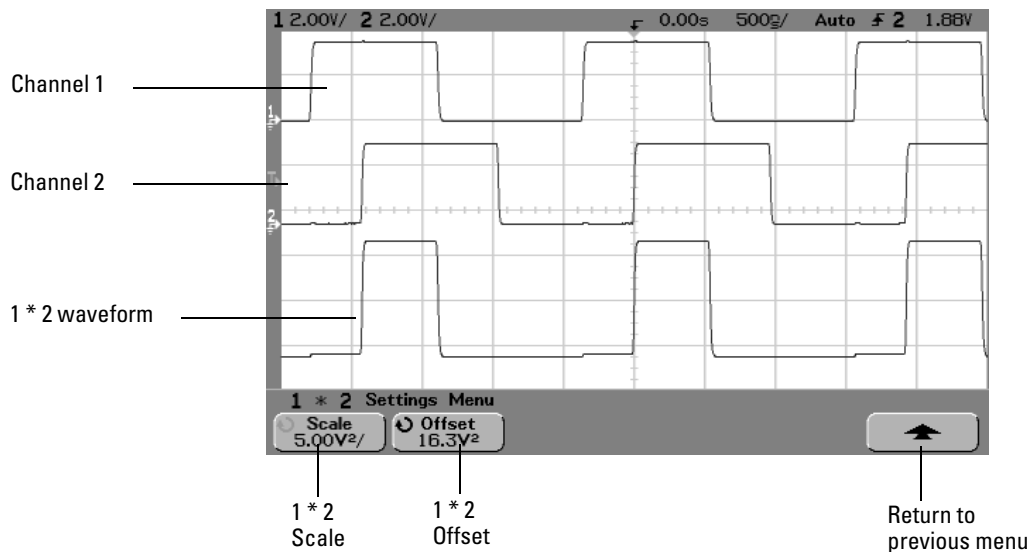

Multiply

Subtract

Subtract

When you select **1 – 2**, channel 2 voltage values are subtracted from channel 1 voltage values point by point, and the result is displayed.

You can use 1 – 2 to make a differential measurement or to compare two waveforms. You may need to use a true differential probe if your waveforms have DC offsets larger than the dynamic range of the oscilloscope's input channel.

To perform the addition of channel 1 and channel 2, select **Invert** in the Channel 2 menu and perform the 1 – 2 math function.

- Press the **Math** key, press the **1 – 2** softkey, then press the **Settings** softkey if you want to change the scaling or offset for the subtract function.

Scale allows you to set your own vertical scale factors for subtract, expressed as V/div (Volts/division) or A/div (Amps/division). Units are set in the channel **Probe** menu. Press the **Scale** softkey, then turn the Entry knob to rescale 1 – 2.

Offset allows you to set your own offset for the 1 – 2 math function. The offset value is in Volts or Amps and is represented by the center graticule of the display. Press the **Offset** softkey, then turn the Entry knob to change the offset for 1 – 2.

A scale unit of **U** (undefined) will be displayed for scale and offset if channel 1 and channel 2 are set to dissimilar units in the channel **Probe Units** softkey.

The figure below shows an example of subtract.

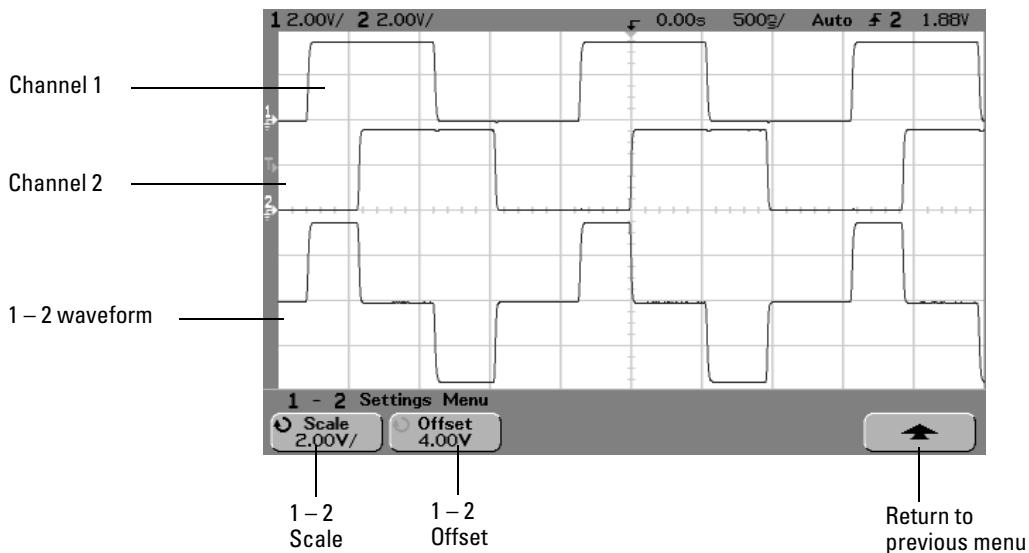

Subtract

Differentiate

d/dt (differentiate) calculates the discrete time derivative of the selected source. You can use differentiate to measure the instantaneous slope of a waveform. For example, the slew rate of an operational amplifier may be measured using the differentiate function. Since differentiation is very sensitive to noise, it is helpful to set acquisition mode to **Averaging** in the **Acquire** menu.

d/dt plots the derivative of the selected source using the "average slope estimate at 4 points" formula. Equation is as follows:

$$d_i = \frac{y_{i+2} + 2y_{i+1} - 2y_{i-1} - y_{i-2}}{8\Delta t}$$

Where

d = differential waveform

y = channel 1, 2, or function 1 + 2, 1 - 2, and 1 * 2 data points

i = data point index

Δt = point-to-point time difference

In Delayed sweep horizontal mode, the d/dt function does not display in the delayed portion of the display.

- Press the **Math** key, press the **d/dt** softkey, then press the **Settings** softkey if you want to change the source, scaling, or offset for the differentiate function.

Source selects the source for d/dt. The source can be any analog channel, or math functions 1 + 2, 1 - 2, and 1 * 2.

Scale allows you to set your own vertical scale factors for d/dt expressed in units/second/division, where units can be V (Volts), A (Amps), or W (Watts). Units are set in the channel **Probe** menu. Press the **Scale** softkey, then turn the Entry knob to rescale d/dt.

Offset allows you to set your own offset for the dV/dt math function. The offset value is in units/second where units can be V (Volts), A (Amps), or W (Watts) and is represented by the center graticule of the display. Press the **Offset** softkey, then turn the Entry knob to change the offset for d/dt.

A scale unit of **U** (undefined) will be displayed for scale and offset when 1-2 or 1+2 is the selected source if channel 1 and channel 2 are set to dissimilar units in the channel **Probe Units** softkey.

Making Measurements

Differentiate

The figure below shows an example of differentiate.

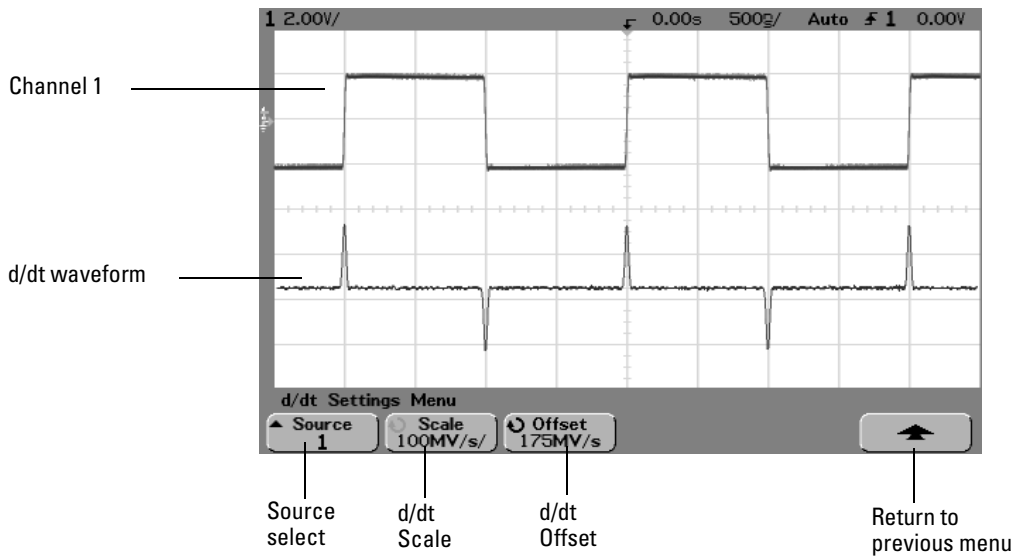

Differentiate

Integrate

$\int dt$ (integrate) calculates the integral of the selected source. You can use integrate to calculate the energy of a pulse in volt-seconds or measure the area under a waveform.

$\int dt$ plots the integral of the source using the "Trapezoidal Rule". Equation is as follows:

$$I_n = c_o + \Delta t \sum_{i=0}^n y_i$$

Where

I = integrated waveform

Δt = point-to-point time difference

y = channel 1, 2, or function 1 + 2, 1 - 2, and 1 * 2 data points

c_o = arbitrary constant

i = data point index

In Delayed sweep horizontal mode, the $\int dt$ function does not display in the delayed portion of the display.

- Press the **Math** key, press the $\int dt$ softkey, then press the **Settings** softkey if you want to change the source, scaling, or offset for the integrate function.

Source selects the source for $\int dt$. The source can be any analog channel, or math functions 1 + 2, 1 - 2, and 1 * 2.

Scale allows you to set your own vertical scale factors for $\int dt$ expressed in unit-seconds/division, where units can be V (Volts), A (Amps), or W (Watts). Units are set in the channel **Probe** menu. Press the **Scale** softkey, then turn the Entry knob to rescale $\int dt$.

Offset allows you to set your own offset for the $\int Vdt$ math function. The offset value is in unit-seconds where units can be V (Volts), A (Amps), or W (Watts) and is represented by the center graticule of the display. Press the **Offset** softkey, then turn the Entry knob to change the offset for $\int dt$.

Making Measurements

Integrate

The integrate calculation is relative to the source signal's offset. The following examples illustrate the effects of signal offset.

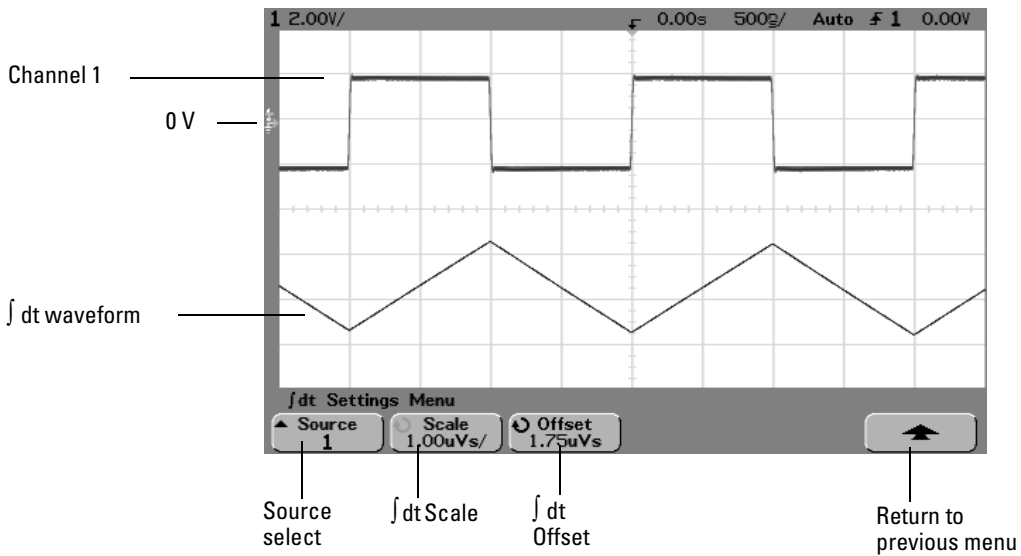
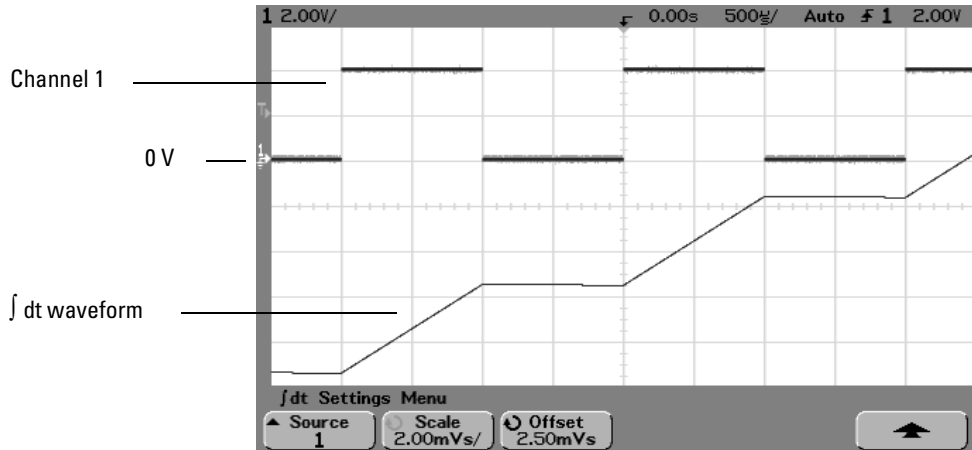

Integrate and Signal Offset

FFT Measurement

FFT is used to compute the fast Fourier transform using analog input channels or math functions 1 + 2, 1 - 2, or 1 * 2. FFT takes the digitized time record of the specified source and transforms it to the frequency domain. When the FFT function is selected, the FFT spectrum is plotted on the oscilloscope display as magnitude in dBV versus frequency. The readout for the horizontal axis changes from time to frequency (Hertz) and the vertical readout changes from volts to dB.

Use the FFT function to find crosstalk problems, to find distortion problems in analog waveforms caused by amplifier non-linearity, or for adjusting analog filters.

FFT Units 0 dBV is the amplitude of a 1 Vrms sinusoid. When the FFT source is channel 1 or channel 2 (or channel 3 or 4 on the 54624A), FFT units will be displayed in dBV when channel units is set to Volts and channel impedance is set to 1 M Ω .

For the 54640-series, FFT units will be displayed in dBm when channel units is set to Volts and channel impedance is set to 50 Ω . For the 54620-series, if you want the result to be in dBm, you must connect a 50 Ω load (10100C or equivalent) to the analog channel input, and then perform the following conversion:

$$\text{dBm} = \text{dBV} + 13.01$$

FFT units will be displayed as dB for all other FFT sources or when a source channel's units has been set to Amps.

DC Value The FFT computation produces a DC value that is incorrect. It does not take the offset at center screen into account. The DC value is not corrected in order to accurately represent frequency components near DC.

Aliasing When using FFTs, it is important to be aware of frequency aliasing. This requires that the operator have some knowledge as to what the frequency domain should contain, and also consider the effective sampling rate, frequency span, and oscilloscope vertical bandwidth when making FFT measurements. The FFT sample rate is displayed directly above the softkeys when the FFT menu is displayed.

Aliasing happens when there are frequency components in the signal higher than half the effective sample rate. Since the FFT spectrum is limited by this frequency, any higher components are displayed at a lower (aliased) frequency.

Making Measurements

FFT Measurement

The following figure illustrates aliasing. This is the spectrum of a 1 kHz square wave, which has many harmonics. The sample rate is set to 200 kSa/s, and the oscilloscope displays the spectrum. The displayed waveform shows the components of the input signal above the Nyquist frequency to be mirrored (aliased) on the display and reflected off the right edge.

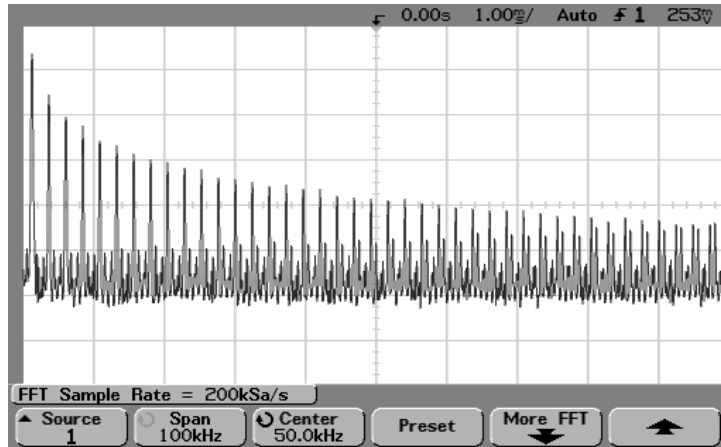

Aliasing

Since the frequency span goes from ≈ 0 to the Nyquist frequency, the best way to prevent aliasing is to make sure that the frequency span is greater than the frequencies of significant energy present in the input signal.

Spectral Leakage The FFT operation assumes that the time record repeats. Unless there is an integral number of cycles of the sampled waveform in the record, a discontinuity is created at the end of the record. This is referred to as leakage. In order to minimize spectral leakage, windows that approach zero smoothly at the beginning and end of the signal are employed as filters to the FFT. The FFT menu provides three windows: Hanning, flattop, and rectangular. For more information on leakage, see Agilent Application Note 243, "The Fundamentals of Signal Analysis" (Agilent part number 5952-8898).

FFT Operation

- 1 Press the **Math** key, press the **FFT** softkey, then press the **Settings** softkey to display the FFT menu.

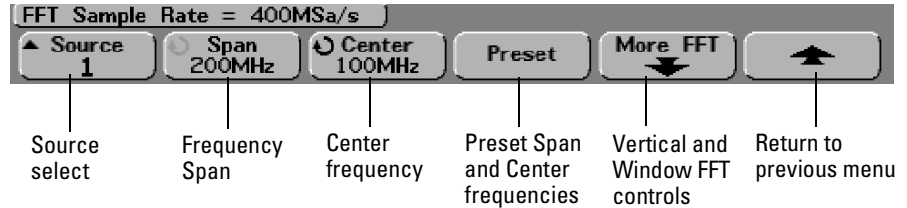

Source selects the source for the FFT. The source can be any analog channel, or math functions $1 + 2$, $1 - 2$, and $1 * 2$.

Span sets the overall width of the FFT spectrum that you see on the display (left graticule to right graticule). Divide span by 10 to calculate the number of Hertz per division. It is possible to set Span above the maximum available frequency, in which case the displayed spectrum will not take up the whole screen. Press the **Span** softkey, then turn the Entry knob to set the desired frequency span of the display.

Center sets the FFT spectrum frequency represented at the center graticule on the display. It is possible to set the Center to values below half the span or above the maximum available frequency, in which case the displayed spectrum will not take up the whole screen. Press the **Center** softkey, then turn the Entry knob to set the desired center frequency of the display.

Preset sets the frequency Span and Center to values that will cause the entire available spectrum to be displayed. The maximum available frequency is half the effective FFT sample rate, which is a function of the time per division setting. The current FFT sample rate is displayed above the softkeys.

FFT Measurement

- 2 Press the More FFT softkey to display additional FFT settings.

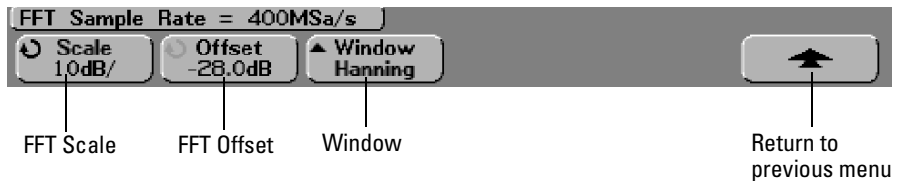

Scale allows you to set your own vertical scale factors for FFT expressed in dB/div (decibels/division). Press the **Scale** softkey, then turn the Entry knob to rescale your math function.

Offset allows you to set your own offset for the FFT. The offset value is in dB and is represented by the center graticule of the display. Press the **Offset** softkey, then turn the Entry knob to change the offset of your math function.

Scale and offset considerations

If you do not manually change the FFT scale or offset settings, when you turn the horizontal sweep speed knob, the span and center frequency settings will automatically change to allow optimum viewing of the full spectrum. If you do manually set scale or offset, turning the sweep speed knob will not change the span or center frequency settings, allowing you see better detail around a specific frequency. Pressing the FFT **Preset** softkey will automatically rescale the waveform and span and center will again automatically track the horizontal sweep speed setting.

Window selects a window to apply to your FFT input signal:

Hanning - window for making accurate frequency measurements or for resolving two frequencies that are close together.

Flat Top - window for making accurate amplitude measurements of frequency peaks.

Rectangular - good frequency resolution and amplitude accuracy, but use only where there will be no leakage effects. Use on self-windowing waveforms such as pseudo-random noise, impulses, sine bursts, and decaying sinusoids.

- 3 To make cursors measurements, press the **Cursors** key and set the **Source** softkey to **Math**.

Use the X1 and X2 cursors to measure frequency values and difference between two frequency values (ΔX). Use the Y1 and Y2 cursors to measure amplitude in dB and difference in amplitude (ΔY).

- 4 To make other measurements, press the **Quick Meas** key and set the **Source** softkey to **Math**.

You can make peak-to-peak, maximum, minimum, and average dB measurements on the FFT waveform. You can also find the frequency value at the first occurrence of the waveform maximum by using the X at Max measurement.

The following FFT spectrum was obtained by connecting the front panel Probe Comp signal (~1.2 kHz from 54620-series) to channel 1. Set sweep speed to 10 ms/div, vertical sensitivity to 1 V/div, Units/div to 10 dB, Offset to -28.0 dB, Center frequency to 5.00 kHz, frequency Span to 10.0 kHz, and window to Hanning.

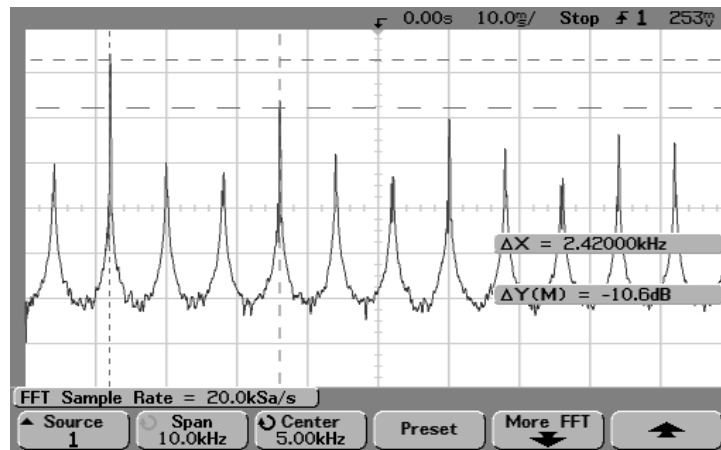

FFT measurements

FFT Measurement Hints

It is easiest to view FFTs with Vectors set to On. The Vector display mode is set in the Display menu.

The number of points acquired for the FFT record 2048 and when frequency span is at maximum, all points are displayed. Once the FFT spectrum is displayed, the frequency span and center frequency controls are used much like the controls of a spectrum analyzer to examine the frequency of interest in greater detail. Place the desired part of the waveform at the center of the screen and decrease frequency span to increase the display resolution. As frequency span is decreased, the number of points shown is reduced, and the display is magnified.

FFT Measurement Hints - Continued

While the FFT spectrum is displayed, use the **Math** and **Cursors** keys to switch between measurement functions and frequency domain controls in FFT menu.

Decreasing the effective sampling rate by selecting a slower sweep speed will increase the low frequency resolution of the FFT display and also increase the chance that an alias will be displayed. The resolution of the FFT is one-half of the effective sample rate divided by the number of points in the FFT. The actual resolution of the display will not be this fine as the shape of the window will be the actual limiting factor in the FFTs ability to resolve two closely space frequencies. A good way to test the ability of the FFT to resolve two closely spaced frequencies is to examine the sidebands of an amplitude modulated sine wave. For example, at 2 MSa/s effective sampling rate, a 1 MHz AM signal can be resolved to 2 kHz. Increasing the effective sampling rate to 4 MSa/s increases the resolution to 5 kHz for a set 2048 point FFT.

For the best vertical accuracy on peak measurements:

- Make sure the probe attenuation is set correctly. The probe attenuation is set from the Channel menu if the operand is a channel.
- Set the source sensitivity so that the input signal is near full screen, but not clipped.
- Use the Flat Top window.
- Set the FFT sensitivity to a sensitive range, such as 2 dB/division.

For best frequency accuracy on peaks:

- Use the Hanning window.
- Use Cursors to place an X cursor on the frequency of interest.
- Adjust frequency span for better cursor placement.
- Return to the Cursors menu to fine tune the X cursor.

For more information on the use of window please refer to Agilent Application Note 243, "The Fundamentals of Signal Analysis" Chapter III, Section 5 (Agilent part number 5952-8898.) Additional information can be obtained from "Spectrum and Network Measurements" by Robert A. Witte, in Chapter 4 (Agilent part number 5960-5718).

Cursor Measurements

You can measure waveform data using cursors. Cursors are horizontal and vertical markers that indicate X-axis values (usually time) and Y-axis values (usually voltage) on a selected waveform source. The position of the cursors can be moved turning the Entry knob. When you press the **Cursors** key, it will illuminate and the cursors will turn on. To turn cursors off, press this key again until it is not illuminated, or press the **Quick Meas** key.

Cursors are not always limited to the visible display. If you set a cursor, then pan and zoom the waveform until the cursor is off screen, its value will not be changed, and if you pan the waveform back again it will have the cursor in the original place.

To make cursor measurements

The following steps guide you through the front-panel **Cursors** key. You can use the cursors to make custom voltage or time measurements on the signal.

- 1 Connect a signal to the oscilloscope and obtain a stable display.
- 2 Press the **Cursors** key, then press the **Mode** softkey.

X and Y cursor information is displayed on the softkeys. ΔX , $1/\Delta X$, ΔY , and binary and hexadecimal values are displayed on the line above the softkeys. The three cursors modes are:

Normal ΔX , $1/\Delta X$, and ΔY values are displayed. ΔX is the difference between the X1 and X2 cursors and ΔY is the difference between the Y1 and Y2 cursors.

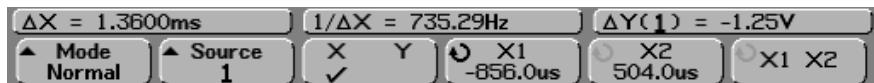

Binary Binary logic levels are displayed directly above the softkeys for the current X1 and X2 cursor positions for all displayed channels.

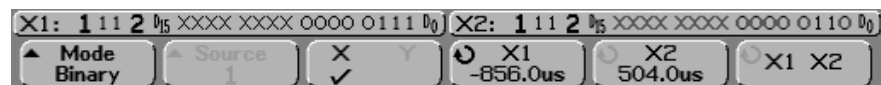

Hex Hexadecimal logic levels are displayed directly above the softkeys for the current X1 and X2 cursor positions for all displayed channels.

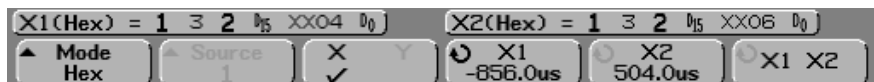

In hexadecimal and binary mode, a level can display as 1 (higher than trigger level), 0 (lower than trigger level), indeterminate state (\updownarrow), or X (don't care). In binary mode, X is displayed if the channel is turned off. In hex mode, the channel is interpreted as a 0 if turned off.

3 Press the **Source** softkey to select the analog channel or math source on which the Y cursors will indicate measurements.

The source in **Normal** cursor mode can be any analog channel or math source. If you select binary or hexadecimal mode, the **Source** softkey is disabled since you are displaying binary or hexadecimal levels for all channels.

4 Select the X and Y softkeys to make a measurement.

X Y Press this softkey to select either X cursors or Y cursors for adjustment. The cursor currently assigned to the Entry knob displays brighter than the other cursors.

X cursors are vertical dashed lines that adjust horizontally and normally indicate time relative to the trigger point. When used with the FFT math function as a source, the X cursors indicate frequency.

Y cursors are horizontal dashed lines that adjust vertically and normally indicate Volts or Amps, dependent on the channel **Probe Units** setting. When math functions are used as a source, the measurement units correspond to that math function.

X1 and X2 The X1 cursor (short-dashed vertical line) and X2 cursor (long-dashed-vertical line) adjust horizontally and indicate time relative to the trigger point for all sources except math FFT (frequency is indicated). In XY horizontal mode, the X cursors display channel 1 values (Volts or Amps). The cursor values for the selected waveform source are displayed within the X1 and X2 softkeys.

The difference between X1 and X2 (ΔX) and $1/\Delta X$ are displayed on the dedicated line above the softkeys or in the display area when some menus are selected.

Turn the Entry knob to adjust the X1 or X2 cursor when its softkey is selected.

Y1 and Y2 The Y1 cursor (short-dashed horizontal line) and Y2 cursor (long-dashed horizontal line) adjust vertically and indicate values relative to the waveform's ground point, except math FFT where the values are relative to 0 dB. In XY horizontal mode, the Y cursors display channel 2 values (Volts or Amps). The cursor values for the selected waveform source are displayed within the Y1 and Y2 softkeys.

The difference between Y1 and Y2 (ΔY) is displayed on the dedicated line above the softkeys or in the display area when some menus are selected.

Turn the Entry knob to adjust the Y1 or Y2 cursor when its softkey is selected.

Making Measurements

To make cursor measurements

X1 X2 Press this softkey to adjust the X1 and X2 cursors together by turning the Entry knob. The ΔX value will remain the same since the cursors adjust together.

You can adjust the X cursors together to check for pulse width variations in a pulse train.

Y1 Y2 Press this softkey to adjust the Y1 and Y2 cursors together by turning the Entry knob. The ΔY value will remain the same since the cursors adjust together.

Cursor Examples

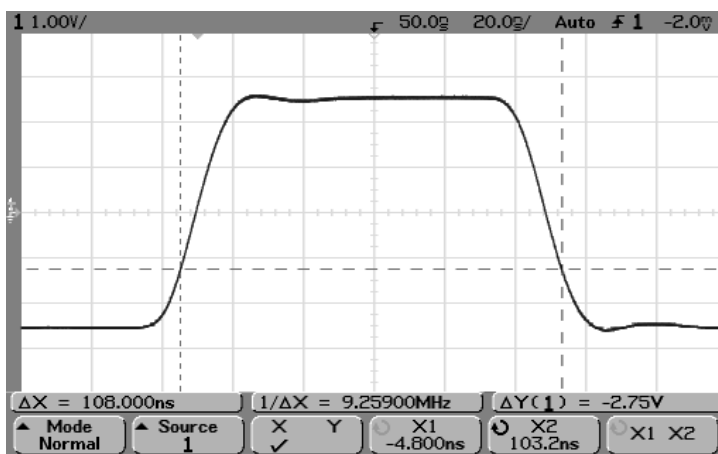

Cursors measure pulse widths other than middle threshold points

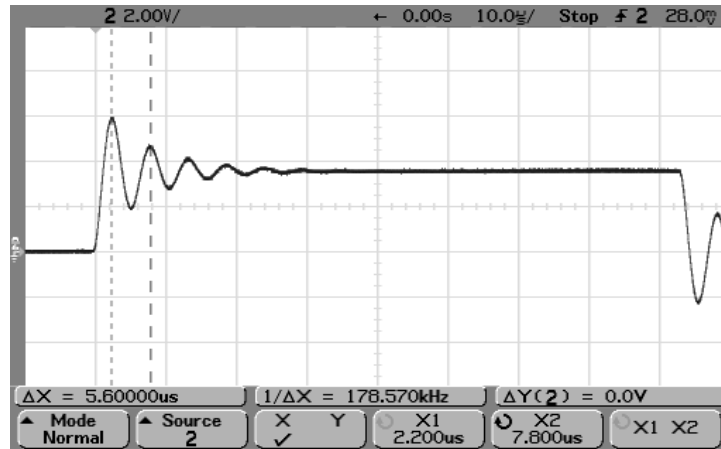

Cursors measure frequency of pulse ringing

Expand the display with delayed sweep, then characterize the event of interest with the cursors.

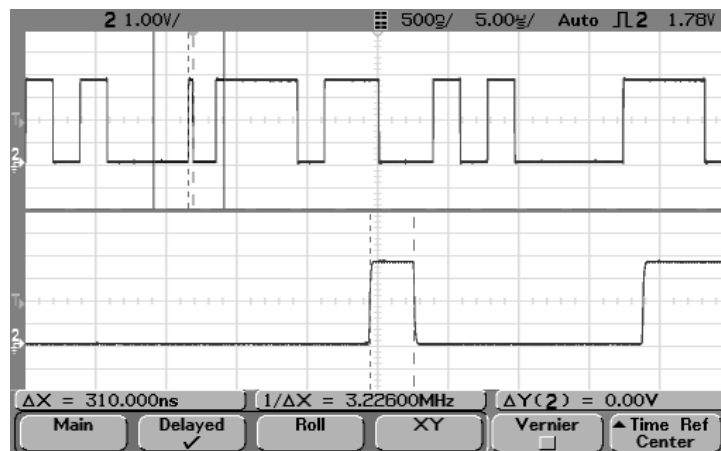

Cursors track delayed sweep

Making Measurements

To make cursor measurements

Put the **X1** cursor on one side of a pulse and the **X2** cursor on the other side of the pulse.

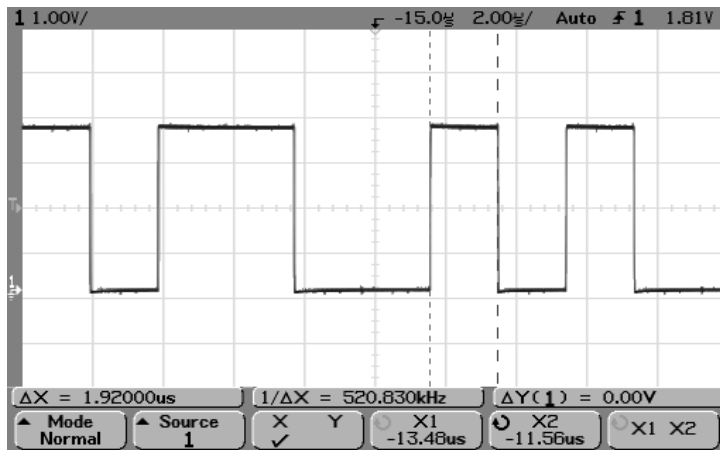

Measuring pulse width with cursors

Press the **X1 X2** softkey and move the cursors together to check for pulse width variations in a pulse train.

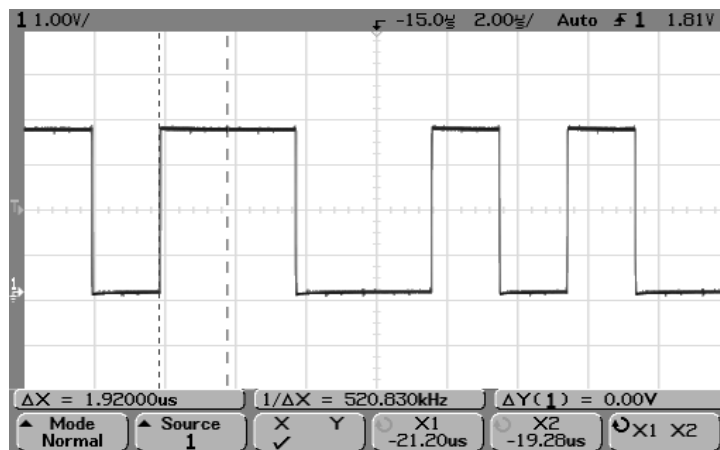

Moving the cursors together to check pulse width variations

Automatic Measurements

The following automatic measurements can be made in the **Quick Meas** menu.

Time Measurements

- Counter
- Duty Cycle
- Frequency
- Period
- Rise Time*
- Fall Time*
- + Width
- - Width
- X at Max*
- X at Min*

Phase and Delay

- Phase*
- Delay*

Voltage Measurements

- Average*
- Amplitude*
- Base*
- Maximum*
- Minimum*
- Peak-to-Peak*
- RMS*
- Top*

Preshoot and Overshoot

- Preshoot*
- Overshoot*

* Measurement on analog channels only.

Making automatic measurements

Quick Meas makes automatic measurements on any channel source or any running math function. The results of the last three measurements selected are displayed on the dedicated line above the softkeys, or in the display area when some menus are selected. Quick Meas also makes measurements on stopped waveforms when you are panning and zooming.

Cursors are turned on to show the portion of the waveform being measured for the most recently selected measurement (right-most on the measurement line).

- 1 Press the **Quick Meas** key to display the automatic measurement menu.

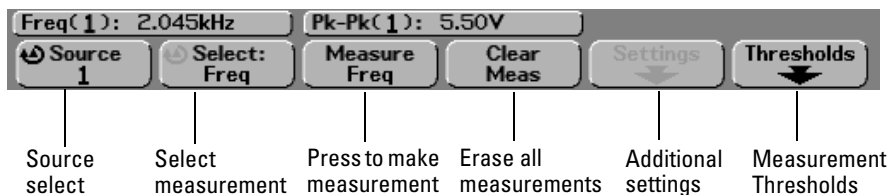

- 2 Press the **Source** softkey to select the channel or running math function on which the quick measurements will be made.

Only channels or math functions that are displayed are available for measurements. If you choose an invalid source channel for a measurement, the measurement will default to the nearest in the list that makes the source valid.

If a portion of the waveform required for a measurement is not displayed or does not display enough resolution to make the measurement, the result will display “No Edges”, “Clipped”, “Low Signal”, “< value”, or “> value”, or a similar message to indicate that the measurement may not be reliable.

- 3 Press the **Clear Meas** softkey to stop making measurements and to erase the measurement results from the display line above the softkeys.

When **Quick Meas** is pressed again, the default measurements will be Frequency and Peak-Peak.

- 4 Press the **Select** softkey then rotate the Entry knob to select a measurement to be made.
- 5 The **Settings** softkey will be available to make additional measurement settings on some measurements.
- 6 Press the **Measure** softkey to make the measurement.
- 7 To turn off **Quick Meas**, press the **Quick Meas** key again until it is not illuminated.

Setting measurement thresholds

Setting measurement thresholds defines the vertical levels where measurements will be taken on an analog channel.

Changing default thresholds may change measurement results

The default lower, middle, and upper threshold values are 10%, 50%, and 90% of the value between Top and Base. Changing these threshold definitions from the the default values may change the returned measurement results for Average, Delay, Duty Cycle, Fall Time, Frequency, Overshoot, Period, Phase, Preshoot, Rise Time, RMS, +Width, and -Width.

- 1 Press the **Thresholds** softkey in the **Quick Meas** menu to set analog channel measurement thresholds.
- 2 Press the **Source** softkey to select the analog channel source for which you want to change measurement thresholds. Each analog channel can be assigned unique threshold values.

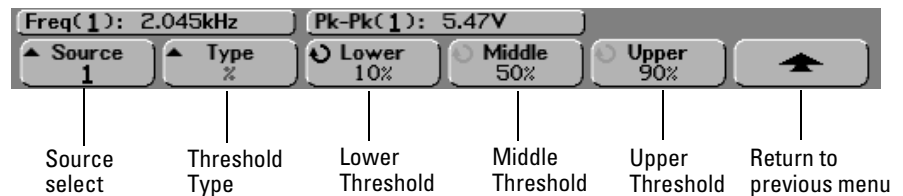

- 3 Press the **Type** softkey to set the measurement threshold to % (percentage of Top and Base value) or to **Absolute** (absolute value.)
 - Percentage thresholds can be set from 5% to 95%.
 - The units for absolute threshold for each channel is set in the channel probe menu.

Absolute threshold hints

- Absolute thresholds are dependent on channel scaling, probe attenuation, and probe units. Always set these values first before setting absolute thresholds.
- The minimum and maximum threshold values are limited to on-screen values.
- If any of the absolute threshold values are above or below the minimum or maximum waveform values, the measurement may not be valid.

Setting measurement thresholds

- 4 Press the **Lower** softkey, then turn the Entry knob to set the lower measurement threshold value.

Increasing the lower value beyond the set middle value will automatically increase the middle value to be more than the lower value. The default lower threshold is 10% or 800 mV.

If threshold **Type** is set to **%**, the lower threshold value can be set from 5% to 93%.

- 5 Press the **Middle** softkey, then turn the Entry knob to set the middle measurement threshold value.

The middle value is bounded by the values set for lower and upper thresholds. The default middle threshold is 50% or 1.20 V.

- If threshold **Type** is set to **%**, the middle threshold value can be set from 6% to 94%.

- 6 Press the **Upper** softkey, then turn the Entry knob to set the upper measurement threshold value.

Decreasing the upper value below the set middle value will automatically decrease the middle value to be less than the upper value. The default upper threshold is 90% or 1.50 V.

- If threshold **Type** is set to **%**, the upper threshold value can be set from 7% to 95%.

Making time measurements automatically

FFT measurements

When you make an **X at Max** or **X at Min** measurement on a math FFT function, the resultant units will be in Hertz. No other time related automatic measurement can be made on the FFT math function. Use the cursors to make other measurements on FFT.

Measurement thresholds for time measurements

The default lower, middle, and upper measurement thresholds are 10%, 50%, and 100% between Top and Base values. See the previous topic "Setting measurement thresholds" for other percentage threshold and absolute value threshold settings.

The following figure shows time measurement points.

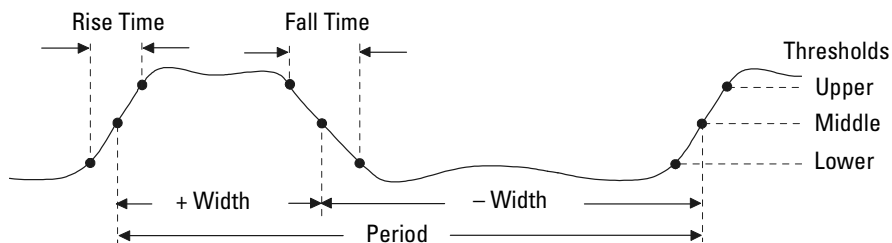

Digital channel time measurements

Automatic time measurements **Delay**, **Fall Time**, **Phase**, **Rise Time**, **X at Max**, **X at Min**, and are not valid for digital channels on the mixed-signal oscilloscope.

Measurement definitions

Measurement thresholds for time measurements

The default lower, middle, and upper measurement thresholds are 10%, 50%, and 100% between Top and Base values. See the previous topic "Setting measurement thresholds" for other percentage threshold and absolute value threshold settings.

Counter

The Counter measurement counts trigger level crossings at the selected trigger slope and displays the results in Hz. The gate time for the measurement is automatically adjusted to be 100 ms or twice the current time window, whichever is longer, up to 1 second. Any channel except Math may be selected for the source. Only one Counter measurement may be displayed at a time.

The Y cursor shows the edge threshold level used in the measurement.

The Counter measurement can measure frequencies up to 125 MHz. The minimum frequency supported is $1/(2 \times \text{gate time})$.

Duty Cycle

The duty cycle of a repetitive pulse train is the ratio of the positive pulse width to the period, expressed as a percentage. The X cursors show the time period being measured. The Y cursor shows the middle threshold point.

$$\text{Duty cycle} = \frac{\text{Width}}{\text{Period}} \times 100$$

Frequency

Frequency is defined as $1/\text{Period}$. Period is defined as the time between the middle threshold crossings of two consecutive, like-polarity edges. A middle threshold crossing must also travel through the lower and upper threshold levels which eliminates runt pulses. The X cursors show what portion of the waveform is being measured. The Y cursor shows the middle threshold point.

Period

Period is the time period of the complete waveform cycle. The time is measured between the middle threshold points of two consecutive, like-polarity edges. A middle threshold crossing must also travel through the lower and upper threshold levels which eliminates runt pulses. The X cursors show what portion of the waveform is being measured. The Y cursor shows the middle threshold point.

Fall Time

The fall time of a signal is the time difference between the crossing of the upper threshold and the crossing of the lower threshold for a negative-going edge. The X cursor shows the edge being measured. For maximum measurement accuracy, set the sweep speed as fast as possible while leaving the complete falling edge of the waveform on the display. The Y cursors show the lower and upper threshold points.

Rise Time

The rise time of a signal is the time difference between the crossing of the lower threshold and the crossing of the upper threshold for a positive-going edge. The X cursor shows the edge being measured. For maximum measurement accuracy, set the sweep speed as fast as possible while leaving the complete rising edge of the waveform on the display. The Y cursors show the lower and upper threshold points.

+ Width

+ Width is the time from the middle threshold of the rising edge to the middle threshold of the next falling edge. The X cursors show the pulse being measured. The Y cursor shows the middle threshold point.

– Width

– Width is the time from the middle threshold of the falling edge to the middle threshold of the next rising edge. The X cursors show the pulse being measured. The Y cursor shows the middle threshold point.

X at Max

X at Max is the X axis value (usually time) at the first displayed occurrence of the waveform Maximum, starting from the left-side of the display. For periodic signals, the position of the maximum may vary throughout the waveform. The X cursor shows where the current X at Max value is being measured.

To measure the peak of an FFT:

- a Select **FFT** as the math function in the **Math** menu.
- b Choose **Math** as the source in the **Quick Meas** menu.
- c Choose **Maximum** and **X at Max** measurements.

Maximum units are in dB and **X at Max** units are in Hertz for FFT.

Making time measurements automatically

X at Min

X at Min is the X axis value (usually time) at the first displayed occurrence of the waveform Minimum, starting from the left-side of the display. For periodic signals, the position of the minimum may vary throughout the waveform. The X cursor shows where the current X at Min value is being measured.

Isolating an event for frequency measurement

The following figure shows how to use delayed sweep to isolate an event for a frequency measurement. If the measurement is not possible in the delayed time base mode, then the main time base is used. If the waveform is clipped, it may not be possible to make the measurement.

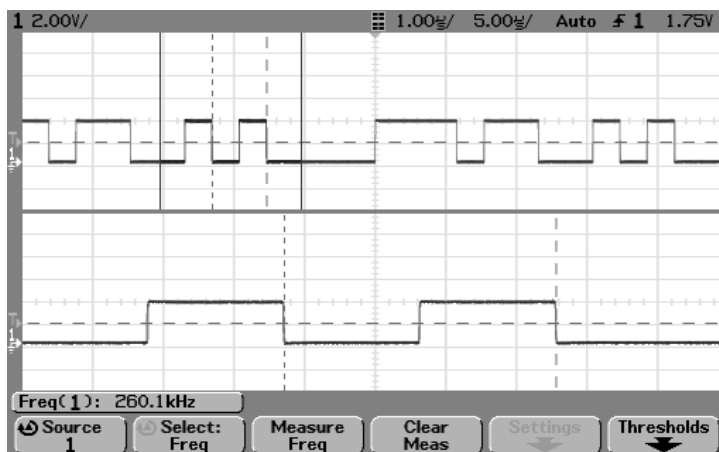

Isolating event for Frequency measurement

Making Delay and Phase Measurements

Digital channel measurements

Automatic measurements **Phase**, and **Delay** are not valid for digital channels on the mixed-signal oscilloscope or for the math FFT function. The two sources defined in the phase and delay measurement must be turned.

Delay

Delay measures the time difference from the selected edge on source 1 and the selected edge on source 2 closest to the trigger reference point at the middle threshold points on the waveforms. Negative delay values indicate that the selected edge of source 1 occurred after the selected edge of source 2.

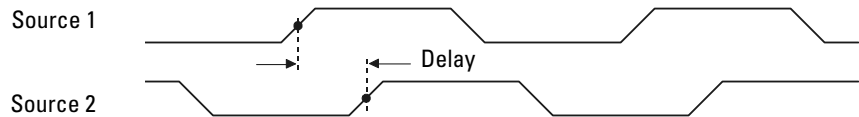

- Press the **Settings** softkey to select the source channels and slope for the delay measurement.

The default Delay settings measure from the rising edge of channel 1 to the rising edge of channel 2.

The example below shows a delay measurement between the rising edge of channel 1 and the falling edge of channel 2.

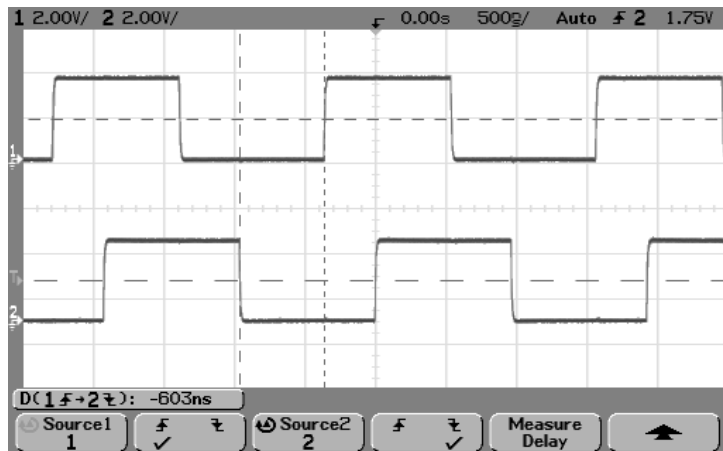

Delay Measurement

Making Measurements

Making Delay and Phase Measurements

Phase

Phase is the calculated phase shift from source 1 to source 2, expressed in degrees. Negative phase shift values indicate that the rising edge of source 1 occurred after the rising edge of source 2. Press the **Settings** softkey to select the source channels for the phase measurement.

$$\text{Phase} = \frac{\text{Delay}}{\text{Source 1 Period}} \times 360$$

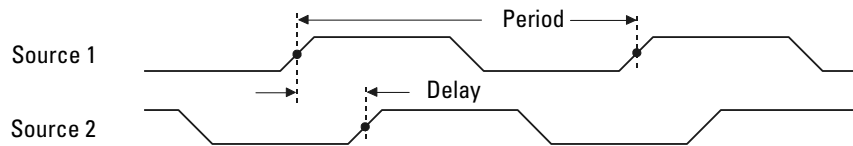

- Press the **Settings** softkey to select the source 1 and source 2 channels for the phase measurement.

The default Phase settings measure from channel 1 to channel 2.

The example below shows a phase measurement between the channel 1 and the math d/dt function on channel 1.

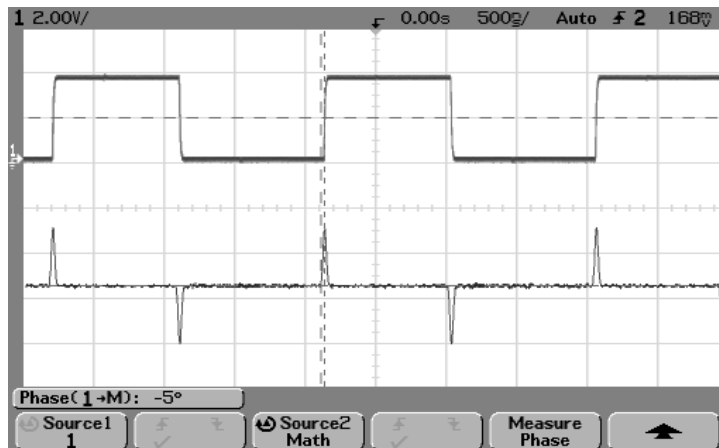

Phase Measurement

Making voltage measurements automatically

Measurement units for each input channel can be set to Volts or Amps using the channel **Probe Units** softkey. A scale unit of **U** (undefined) will be displayed for math function 1-2 and for d/dt, and $\int dt$ when 1-2 or 1+2 is the selected source if channel 1 and channel 2 are set to dissimilar units in the channel **Probe Units** softkey.

Math Measurements and Units

Only Peak-Peak, Maximum, Minimum, Average, X at Min, and X at Max automatic measurements may be made on a math FFT function. See "Making time measurements automatically" for the FFT X at Max and X at Min measurement. Use the cursors to make other measurements on FFT. All voltage measurements may be made on other math functions. The resultant units are:

FFT:	dB* (decibels)
1 * 2:	V ² , A ² or W (Volt-Amp)
1 – 2:	V (Volts) or A (Amps)
d/dt:	V/s or A/s (V/second A/second)
$\int dt$:	Vs or As (V-seconds or A-seconds)

* When the FFT source is channel 1 or channel 2 (or channel 3 or 4 on the 54624A), FFT units will be displayed in dBV when channel units is set to Volts and channel impedance is set to 1 M Ω . FFT units will be displayed in dBm when channel units is set to Volts and channel impedance is set to 50 Ω (54640-series only). FFT units will be displayed as dB for all other FFT sources or when a source channel's units has been set to Amps.

The following figure shows the voltage measurement points.

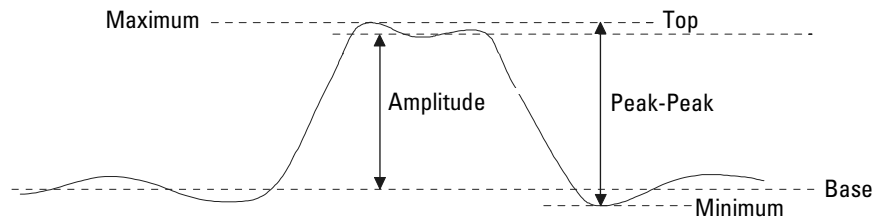

Digital channel voltage measurements

Automatic voltage measurements are not valid on digital channels on the mixed-signal oscilloscope.

Measurement definitions

Amplitude

The Amplitude of a waveform is the difference between its Top and Base values. The Y cursors show the values being measured.

Average

Average is the sum of the waveform samples divided by the number of samples over one or more full periods. If less than one period is displayed, Average is calculated on the full width of the display. The X cursors show what portion of the displayed waveform is being measured.

$$\text{Average} = \frac{\sum x_i}{n} \quad \text{where } x_i = \text{value at } i\text{th point being measured}$$

$n = \text{number of points in measurement interval}$

Base

The Base of a waveform is the mode (most common value) of the lower part of the waveform, or if the mode is not well defined, the base is the same as Minimum. The Y cursor shows the value being measured.

Maximum

Maximum is the highest value in the waveform display. The Y cursor shows the value being measured.

Minimum

Minimum is the lowest value in the waveform display. The Y cursor shows the value being measured.

Peak-Peak

The peak-to-peak value is the difference between Maximum and Minimum values. The Y cursors show the values being measured.

RMS

RMS (dc) is the root-mean-square value of the waveform over one or more full periods. If less than one period is displayed, RMS (dc) average is calculated on the full width of the display. The X cursors show what interval of the waveform is being measured.

$$\text{RMS (dc)} = \sqrt{\frac{\sum_{i=1}^n x_i^2}{n}}$$

where x_i = value at i th point being measured
 n = number of points in measurement interval

Top

The Top of a waveform is the mode (most common value) of the upper part of the waveform, or if the mode is not well defined, the top is the same as Maximum. The Y cursor shows the value being measured.

Using delayed sweep to isolate a pulse for Top measurement

The following figure shows how to use delayed sweep to isolate a pulse for a **Top** measurement.

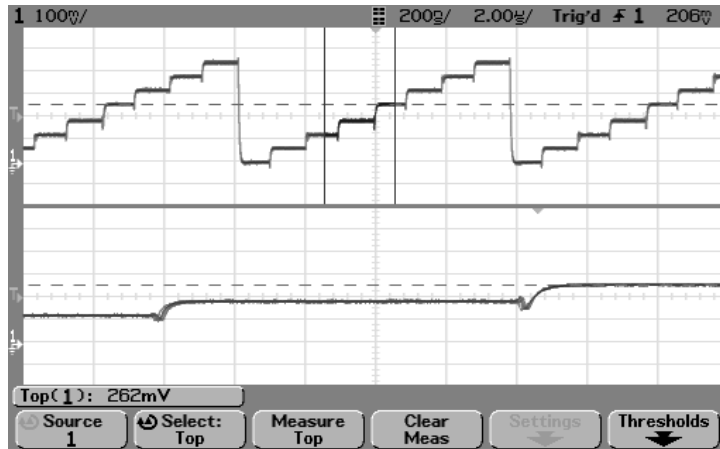

Isolating area for Top measurement

Making overshoot and preshoot measurements

Digital channel time measurements

Automatic measurements **Preshoot** and **Overshoot** are not valid measurements for the math FFT function or for digital channels on the mixed-signal oscilloscope.

Measurement definitions

Preshoot

Preshoot is distortion that precedes a major edge transition expressed as a percentage of Amplitude. The X cursors show which edge is being measured (edge closest to the trigger reference point).

$$\text{Rising edge preshoot} = \frac{\text{Base} - \text{local Minimum}}{\text{Amplitude}} \times 100$$

$$\text{Falling edge preshoot} = \frac{\text{local Maximum} - \text{Top}}{\text{Amplitude}} \times 100$$

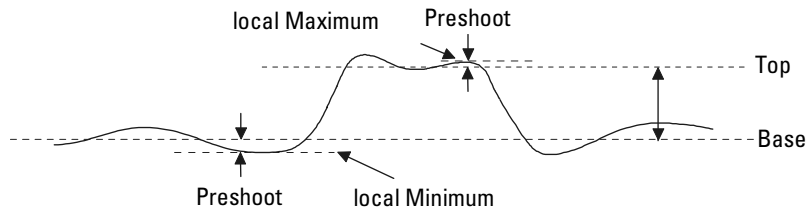

Overshoot

Overshoot is distortion that follows a major edge transition expressed as a percentage of Amplitude. The X cursors show which edge is being measured (edge closest to the trigger reference point).

$$\text{Rising edge overshoot} = \frac{\text{local Maximum} - \text{Top}}{\text{Amplitude}} \times 100$$

$$\text{Falling edge overshoot} = \frac{\text{Base} - \text{local Minimum}}{\text{Amplitude}} \times 100$$

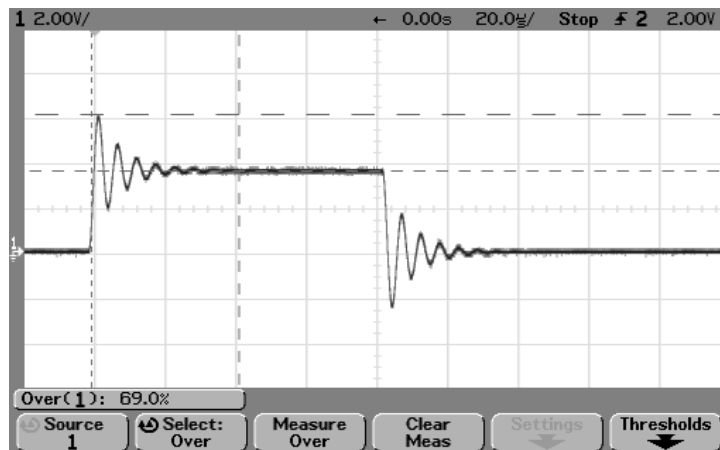
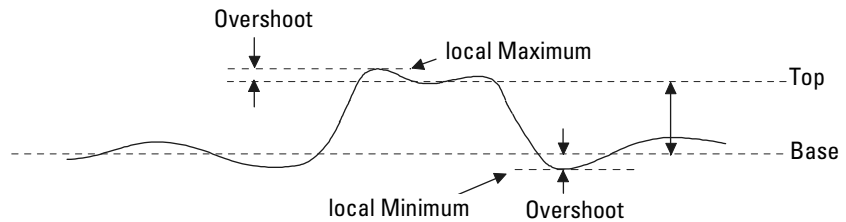

Automatic Overshoot measurement

Making overshoot and preshoot measurements

Utilities

The Utility menu allows you to:

- select other languages for viewing Quick Help
 - set up the oscilloscope printer interface
 - load and delete floppy disk files
 - set up the oscilloscope I/O ports for controller operation
 - set up the real-time clock
 - to set up the screen saver
 - perform service functions such as User Cal and Self Test
-
- Press the **Utility** key to display the Utility menu.



To configure Quick Help languages

You can choose to display Quick Help in any of 11 languages.

- 1 Press the **Utility** key, then press the **Language** softkey to display the Language menu.
- 2 Press the **Language** softkey until the desired language in the list is selected.

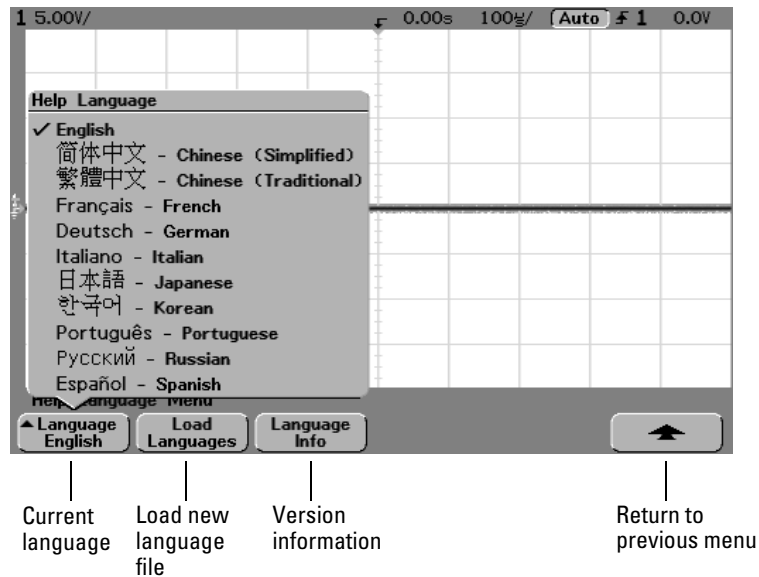

To configure Quick Help languages

Loading an updated language file from floppy disk

When updates occur, an updated language file can be downloaded from:

www.agilent.com/find/5462xsw for the 54620-series or

www.agilent.com/find/5464xsw for the 54640-series,

or call an Agilent center and request a language disk for your instrument.

- 1 Insert the floppy disk containing the language file into the floppy disk drive on the oscilloscope.
- 2 Press the **Utility** key, then press the **Language** softkey to display the Language menu.
- 3 Press the **Load Languages** softkey to load the updated language file into the oscilloscope.

The message

Loading Language file. Please Wait.

will be displayed as the new language file is being loaded into the oscilloscope.

- 4 Press the **Language** softkey and select the language to be viewed.

Language Info softkey

- Press the **Language Info** softkey to show the Quick Help system version and what languages are loaded into the oscilloscope.

The oscilloscope is shipped from the factory with English, French, German, Italian, Japanese, Korean, Portuguese (Brazilian), Russian, Spanish, Simplified Chinese, and Traditional Chinese languages loaded.

To update your instrument to the latest application software

When updates to the instrument application software occur, an updated application software file can be downloaded from:

www.agilent.com/find/5462xsw for the 54620-series or

www.agilent.com/find/5464xsw for the 54640-series,

or call an Agilent center and request the latest application software disk for your instrument.

Always update your localized Quick Help file to match the latest instrument application software

If you update your application software, always update your Quick Help localized languages to the latest version by downloading the language file from the above web site. English Quick Help is built into the application software.

To configure a printer

Use the printer configuration menu to set up your printer interface and printer format type. You can also turn scale factors, gray scale, and form feed on and off.

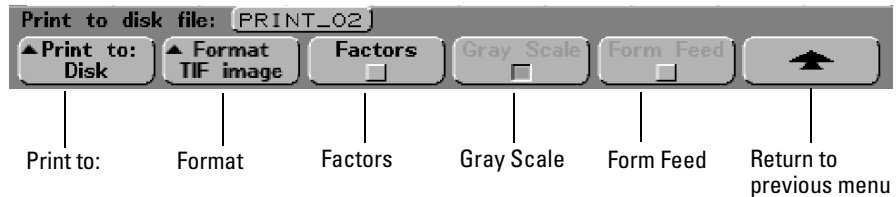

- 1 Press the **Utility** key, then press the **Print Config** softkey to display the print configuration menu.
- 2 Press the **Print to:** softkey to select the printer interface.

Parallel prints to the printer connected to the parallel port on the back of the oscilloscope.

Disk sends a print file to the built-in floppy disk. The print file will be named **PRINT_nn.xxx**, where **xxx** is the format of the output (BMP, TIF, or CSV). If you print to the floppy disk again, the number **nn** will automatically increment (starting at **00**) each time you save a new file to floppy disk. Up to 100 files can be saved on each floppy disk if space permits.

- 3 Press the **Format** softkey to select the print format.

- If the printer interface is set to **Parallel**, you can select your printer format to be **DeskJet**, **LaserJet**, **Epson**, or **Seiko DPU 414 (portable)**.

The portable Seiko DPU 414 printer kit is available by ordering Agilent model N2727A. The kit is a printer mounted in a pouch that attaches to the top of the oscilloscope.

- If the printer interface is set to **Disk**, you can print to the built-in floppy disk. The floppy disk format can be set to:

TIF image tiff format of the complete screen image, including the status line and softkeys.

BMP image bitmap format of the complete screen image, including the status line and softkeys.

CSV data comma-separated variable, values of displayed channels and math waveforms suitable for spreadsheet analysis.

CSV length

The **Length** softkey sets the number of XY waveform pair values that will be output to the CSV (comma-separated variable) file. Length can be set to 100, 250, 500, 1000, or 2000 waveform pairs by turning the Entry knob. The larger the length, the longer the file will take to write to the floppy disk.

Scale factors

Select the **Factors** softkey if you want the oscilloscope scale factors to be included on your print. If you print to a disk image file, the scale factors will be sent to a separate file named **PRINT_nn.TXT**. If you print to a CSV file, the factors will be appended to the end of the file.

Oscilloscope scale factors include vertical, horizontal, trigger, acquisition, math, and display settings.

Gray scale printing

When the **Gray Scale** softkey is selected, the gray scale (all levels of display intensities) traces on the oscilloscope display are printed if the **Format** softkey has been set to **LaserJet** or **DeskJet** printer. Gray scale information is always sent when you print to a TIF or BMP image file on the floppy disk.

If gray scale is turned off, the gray scale traces will be printed in black and white. For fastest print throughput, turn gray scale off.

Gray scale printing is not available with Epson or Seiko formats and is not applicable to CSV format.

Form feed

When on, **Form Feed** will send a form feed command to the parallel printer when the print is complete. Use this if you want only one print per sheet of paper. Set form feed off when you want to put more than one print on a sheet of paper. Form feed is not applicable when printing to the floppy disk.

To use the floppy disk

The Floppy menu allows you to load or delete files from the floppy disk.

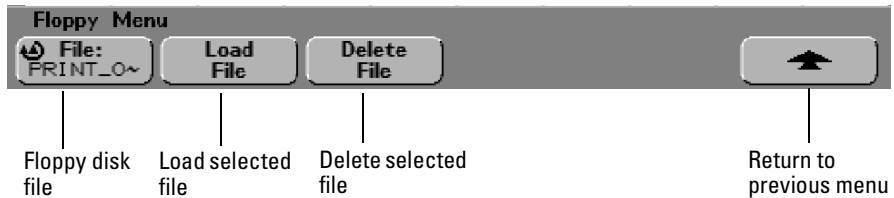

- 1 Press the **File:** softkey or turn the Entry knob to select a file on the floppy disk.
- 2 To load a file into the oscilloscope press the **Load File** softkey.

Files that can be loaded into the oscilloscope:

- **QFILE_nn.SCP** setup files, **QFILE_nn.TRC** trace files, and other user-defined setup or trace files that were created using the **Save/Recall** key on the front panel of the oscilloscope.
- Localized language pack files (**LANGPACK.JZP**).
- System software files (***.BIN** and ***.JZP**).

Files that cannot be loaded into the oscilloscope:

- Any **PRINT_nn.xxx** printer file.
- Any other file not created by the oscilloscope.

- 3 To delete a file from the floppy disk, press the **Delete File** softkey.

Deleted files cannot be recovered

A file that has been deleted from the floppy disk cannot be recovered by the oscilloscope.

To set up the I/O port to use a controller

Use the I/O menu to make settings if you have a controller connected to the oscilloscope.

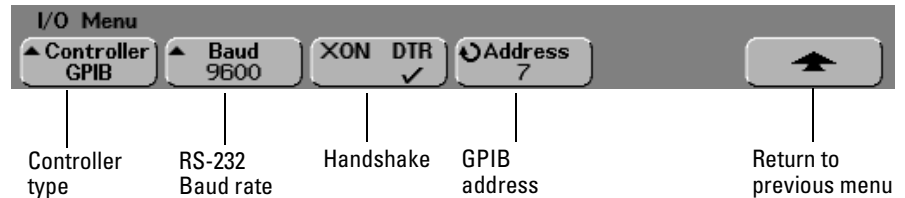

- 1 Press the **Controller** softkey to set the controller interface to RS-232 or GPIB.

GPIB will be a selection on this softkey only if you have the optional N2757A GPIB Interface Module connected to the oscilloscope.

The **RS-232** configuration to the connector on the rear panel is:

- Data bits - 8
- Stop bits - 1
- Parity - none

- 2 Press the **XON DTR** softkey to set the RS-232 handshake.

The RS-232 handshake protocol can be set to:

XON XON (transmit on)/XOFF (transmit off), a software handshake, or
DTR data terminal ready, a hardware handshake.

The default handshake is **DTR**.

- 3 Press the **Baud** softkey to set the RS-232 baud rate.

The RS-232 baud rate can be set to 9600, 19200, 38400, or 57600.

The default baud rate is 9600.

- 4 If you have the optional N2757A GPIB Interface Module connected to the oscilloscope, turn the Entry knob to set the GPIB address shown in the **Address** softkey.

The **Address** softkey is only displayed if the GPIB module is attached to the oscilloscope.

Turn the Entry knob to set the GPIB address of this oscilloscope. The oscilloscope address can be set to any address from 0 to 30. The default oscilloscope address is 7.

To set up the I/O port to use a controller

RS-232 Connections

The signals for the 9-pin RS-232 port on the oscilloscope is listed below.

Pin Number	Signal
1	Data Carrier Detect
2	Receive Data
3	Transmit Data
4	Data Terminal Ready
5	Signal Ground
6	Data Set Ready
7	Request to Send
8	Clear to Send
9	Ring
SHELL	Protective Ground

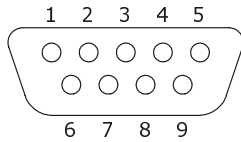

Pin out of oscilloscope RS-232 port looking into DB9 male connector

The follow figure shows the pin out of the recommended Agilent 34398A RS-232 cable.

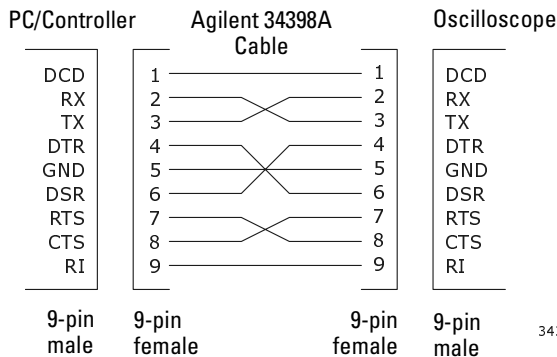

Pin out of Agilent 34398A RS-232 cable

To set the clock

The Clock menu allows you to set the current date and time of day (24-hour format). This time/date stamp will appear on hardcopy prints and directory information on the floppy disk.

To set the date and time, or to view the current date and time:

- 1 Press the **Utility** key, press the **Options** softkey, then press the **Clock** softkey to display the Clock menu.

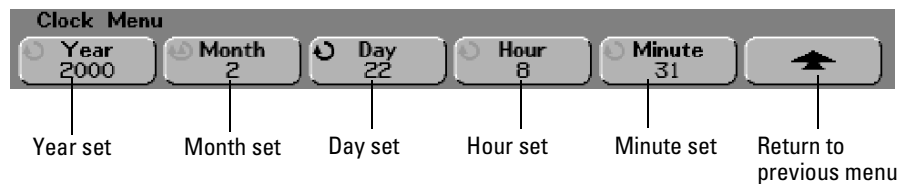

- 2 Press the **Year**, **Month**, **Day**, **Hour** (24-hour format), or **Minute** softkey and rotate the Entry knob to set to the desired number.

The real-time clock only allows selection of valid dates. If a day is selected and the month or year is changed so the day is now invalid, the day is automatically adjusted.

To set up the screen saver

To set up the screen saver

The oscilloscope can be configured to turn on a display screen saver when the oscilloscope has been idle for a specified length of time.

- 1 Press the **Utility** key, press the **Options** softkey, then press the **Screen Svr** softkey to display the screen saver menu.

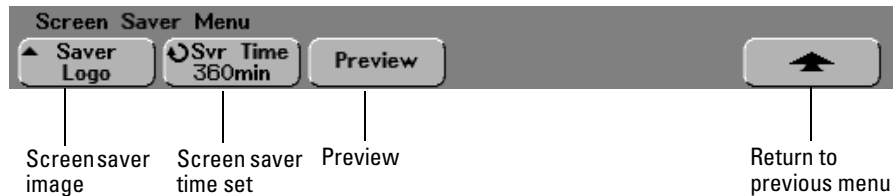

- 2 Press the **Saver** softkey to select the screen saver type.

The screen saver can be set to **Off**, to display any of the images shown in the list, or can display a user-defined text string.

If **User** was selected, **Spell** selects a character to put in the highlighted position shown in the "**Text** =" line above the softkeys.

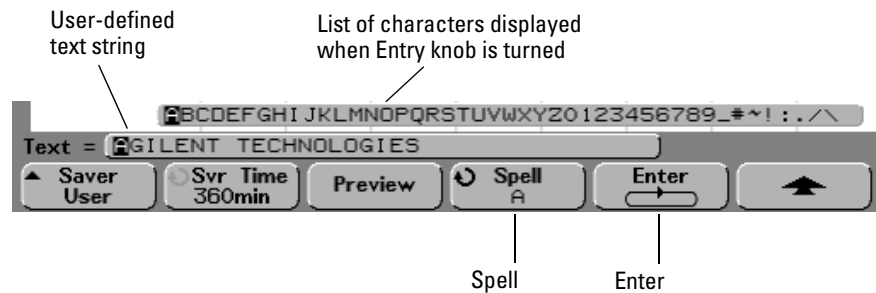

- a You may position the highlight on any character in the text string by successively pressing the **Enter** key.
- b Press the **Spell** softkey, then turn the Entry knob to choose from a list of characters to enter in your user-defined text string.
- c Press the **Enter** softkey to advance to the next character in the text string. Pressing **Enter** saves the character shown in the **Spell** softkey to the character position highlighted in the "**Text** =" line above the softkeys. The highlight then advances to the next character position in the text string. The text string can be up to 35 characters long.

- 3 Turn the Entry knob to select the number of minutes to wait before the selected screen saver activates.

When you turn the Entry knob, the number of minutes is displayed in the **Svr Time** softkey. The default time is 360 minutes (6 hours). The screen saver starts automatically if your oscilloscope is idle for the number of minutes specified in the **Svr Time** softkey.

- 4 Press the **Preview** softkey to preview the screen saver you have selected with the **Saver** softkey.
- 5 To view the normal display after the screen saver has started, press any key or turn any knob.

To perform service functions

The Service menu allows you to:

- perform User Cal on the oscilloscope
- view User Cal status
- perform instrument Self Test
- view information about your oscilloscope model number, code revision information, modules attached, and User Cal status.
- Press the **Utility** key, then press the **Service** softkey to display the service menu.

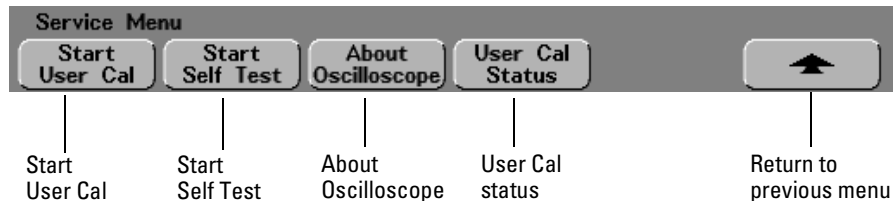

User Cal

User Cal performs an internal self-alignment routine to optimize the signal path in the oscilloscope. The routine uses internally generated signals to optimize circuits that affect channel sensitivity, offset, and trigger parameters.

Disconnect all inputs and allow the oscilloscope to warm up before performing this procedure.

54640-only - before pressing **Start User Cal**, connect the rear-panel Trig Out output to analog Channel 1 and Channel 2 inputs using a BNC tee adapter and equal length cables.

User Cal should be performed at least once a year, any time the ambient temperature of the oscilloscope has changed more than 10 °C since the last User Cal, or after any repair.

Performing User Cal will not invalidate your Certificate of Calibration.

Successful completion of User Cal does not certify this oscilloscope with a National Institute of Standards and Technology (NIST) calibration.

- Press **Start User Cal** to start the routine

User Cal Status

Pressing the **User Cal Status** softkey displays the following summary results of the previous User Cal.

Results:
User Cal date:
DT since last User Cal:
Failure:
Comments:

Self test

Pressing the **Start Self Test** softkey performs a series of internal procedures to verify that the oscilloscope and any attached module are operating properly.

It is recommended you run Self Test:

- after experiencing abnormal operation.
- for additional information to better describe an oscilloscope failure.
- to verify proper operation after the oscilloscope has been repaired.

Successfully passing Self Test does not guarantee 100% of the oscilloscope's functionality. Self Test is designed to provide an 80% confidence level that the oscilloscope is operating properly.

About Oscilloscope

Pressing the **About Oscilloscope** softkey displays information about your oscilloscope model number, serial number, software revision, ROM revision, and option module attached.

To set other options

The options menu contains two additional softkeys to help configure the oscilloscope.

Expand softkey

When you change a channel's volts/division setting, the waveform display can be set to expand about ground or set to expand about the center of the display.

Expand About Ground the displayed waveform will expand about the position of the channel's ground. This is the default setting. The ground level of the signal is identified by the position of the ground level () icon at the far-left side of the display. If the ground level is off screen, the waveform will expand about the top or bottom edge of the screen based on where the ground is off screen.

Expand About Center the displayed waveform will expand about the center graticule on the display.

Default Library softkey (mixed-signal oscilloscopes only)

Press the **Default Library** softkey to set the labels in the front-panel **Label Library** softkey back to the factory default labels. This will delete all user-defined labels. Full information about digital channel labels is discussed at the end of the "Megazoom Concepts and Oscilloscope Operation" chapter.

Performance Characteristics

This chapter lists the performance characteristics for the Agilent 54620-series and 54640-series oscilloscopes.

- The 54620-series performance characteristics start on page 7-3.
The 54640-series performance characteristics start on page 7-13.

Agilent 54620-series Performance Characteristics

* Denotes Warranted Specifications, all others are typical. Specifications are valid after a 30-minute warm-up period and $\pm 10\text{ }^{\circ}\text{C}$ from firmware calibration temperature.

Acquisition: Analog Channels

Max Sample rate	200 MSa/s
Max Memory Depth	4 MB interleaved, 2 MB each channel
Vertical Resolution	8 bits
Peak Detection	5 ns
Averages	selectable from 2, 4, 8, 16, 32, 64 ...to 16383
High Resolution Mode	12 bits of resolution when $\geq 500\text{ us/div}$, average mode with average = 1
Filter:	Sinx/x interpolation (single shot BW = sample rate/4 or bandwidth of scope, whichever is less) with vectors on.

Acquisition: Digital Channels (on 54621D and 54622D only)

Max Sample Rate	400 MSa/s interleaved, 200 MSa/s each channel
Max Memory Depth	8 MB interleaved, 4 MB each channel
Vertical Resolution	1 bit
Glitch Detection (min pulse width)	5 ns

Performance Characteristics
Agilent 54620-series Performance Characteristics

* Denotes Warranted Specifications, all others are typical. Specifications are valid after a 30-minute warm-up period and $\pm 10^\circ\text{C}$ from firmware calibration temperature.

Vertical System: Analog Channels

Analog channels	54621A/21D, 54622A/22D: Ch1 and 2 simultaneous acquisition 54624A: Ch 1, 2, 3, and 4 simultaneous acquisition
Bandwidth (-3dB)*	54621A/22D: dc to 60 MHz 54622A/22D/24A: dc to 100 MHz
ac coupled	54621A/21D: 3.5 Hz to 60 MHz 54622A/22D/24A: 3.5 Hz to 100 MHz
Calculated rise time (= 0.35/bandwidth)	54621A/22D: ~5.8 ns 54622A/22D/24A: ~3.5 ns
Single Shot Bandwidth Range ¹	50 MHz 1 mV/div to 5 V/div
Maximum Input	 CAT I 300 Vrms, 400 Vpk CAT II 100 Vrms, 400 Vpk with 10074C 10:1 probe: CAT I 500 Vpk, CAT II 400 Vpk
Offset Range	$\pm 5\text{ V}$ on ranges $< 10\text{ mV/div}$ $\pm 25\text{ V}$ on ranges 10 mV/div to 199 mV/div $\pm 100\text{ V}$ on ranges $\geq 200\text{ mV/div}$
Dynamic Range	Lesser of $\pm 8\text{ div}$ or $\pm 32\text{ V}$
Input Resistance	$1\text{ M}\Omega \pm 1\%$
Input Capacitance	$\sim 14\text{ pF}$
Coupling	ac, dc, ground
BW Limit	$\sim 20\text{ MHz}$ selectable
Channel-to-Channel Isolation (with channels at same V/div)	dc to $20\text{ MHz} > 40\text{ dB}$ 20 MHz to max bandwidth $> 30\text{ dB}$
Probes	10:1 10074C shipped standard for each analog channel
Probe ID (Agilent/HP & Tek Compatible)	Auto probe sense

¹ 1 mV/div is a magnification of 2 mV/div setting. For vertical accuracy calculations, use full scale of 16 mV for 1 mV/div sensitivity setting.

* Denotes Warranted Specifications, all others are typical. Specifications are valid after a 30-minute warm-up period and $\pm 10^\circ\text{C}$ from firmware calibration temperature.

Vertical System: Analog Channels (continued)

ESD Tolerance	$\pm 2\text{ kV}$
Noise Peak-to-Peak	2% full scale or 1 mV, whichever is greater
Common Mode Rejection Ratio	20 dB @ 50 MHz
DC Vertical Gain Accuracy* ¹	$\pm 2.0\%$ full scale
DC Vertical Offset Accuracy	< 200 mV/div: $\pm 0.1\text{ div} \pm 1.0\text{ mV} \pm 0.5\%$ offset $\geq 200\text{ mV/div}$: $\pm 0.1\text{ div} \pm 1.0\text{ mV} \pm 1.5\%$ offset value
Single Cursor Accuracy ¹	$\pm\{\text{DC Vertical Gain Accuracy} + \text{DC Vertical Offset Accuracy} + 0.2\% \text{ full scale } (\sim 1/2 \text{ LSB})\}$ <i>Example:</i> For 50 mV signal, scope set to 10 mV/div (80 mV full scale), 5 mV offset, accuracy = $\pm\{2.0\%(80\text{mV}) + 0.1 (10\text{ mV}) + 1.0\text{ mV} + 0.5\% (5\text{ mV}) + 0.2\%(80\text{ mV})\} = \pm 3.78\text{ mV}$
Dual Cursor Accuracy* ¹	$\pm\{\text{DC Vertical Gain Accuracy} + 0.4\% \text{ full scale } (\sim 1 \text{ LSB})\}$ <i>Example:</i> For 50 mV signal, scope set to 10 mV/div (80 mV full scale), 5 mV offset, accuracy = $\pm\{2.0\%(80\text{ mV}) + 0.4\%(80\text{ mV})\} = \pm 1.92\text{ mV}$

¹ 1 mV/div is a magnification of 2 mV/div setting. For vertical accuracy calculations, use full scale of 16 mV for 1 mV/div sensitivity setting.

Vertical System: Digital Channels (54621D and 54622D only)

Number of Channels	16 Digital – labeled D15 – D0
Threshold Groupings	Pod 1: D7 - D0 Pod 2: D15 - D8
Threshold Selections	TTL, CMOS, ECL, user-definable (selectable by pod)
User-Defined Threshold Range	$\pm 8.0\text{ V}$ in 10 mV increments
Maximum Input Voltage 	$\pm 40\text{ V}$ peak CAT I
Threshold Accuracy*	$\pm(100\text{ mV} + 3\% \text{ of threshold setting})$
Input Dynamic Range	$\pm 10\text{ V}$ about threshold
Minimum Input Voltage Swing	500 mV peak-to-peak
Input Capacitance	$\sim 8\text{ pF}$
Input Resistance	100 k Ω $\pm 2\%$ at probe tip
Channel-to-Channel Skew	2 ns typical, 3 ns maximum

Performance Characteristics
Agilent 54620-series Performance Characteristics

* Denotes Warranted Specifications, all others are typical. Specifications are valid after a 30-minute warm-up period and ± 10 °C from firmware calibration temperature.

Horizontal

Range	5 ns/div to 50 s/div
Resolution	25 ps
Vernier	1-2-5 increments when off, 25 minor increments between major settings when on
Reference Positions	Left, Center, Right
Delay Range	
Pre-trigger (negative delay)	Greater of 1 screen width or 10 ms
Post-trigger (positive delay)	500 seconds
Analog Delta-t Accuracy	
Same Channel*	$\pm 0.01\%$ reading $\pm 0.1\%$ screen width ± 40 ps <i>Example:</i> for signal with pulse width of 10 us, scope set to 5 us/div (50 us screen width), delta-t accuracy = $\pm\{.01\%(10\text{ us}) + 0.1\% (50\text{ us}) + 40\text{ ps}\} = 51.04\text{ ns}$
Channel-to-Channel	$\pm 0.01\%$ reading $\pm 0.1\%$ screen width ± 80 ps
Digital Delta-t Accuracy	(non-Vernier settings)
Same Channel	$\pm 0.01\%$ reading $\pm 0.1\%$ screen width $\pm (1$ digital sample period, 2.5 or 5 ns based on sample rate of 200/400 MSa/s) <i>Example:</i> for signal with pulse width of 10 us, scope set to 5 us/div (50 us screen width), and single pod active (400 MSa/s), delta-t accuracy = $\pm\{.01\%(10\text{ us}) + 0.1\% (50\text{ us}) + 2.5\text{ ns}\} = 53.5\text{ ns}$
Channel-to-Channel	$\pm 0.01\%$ reading $\pm 0.1\%$ screen width $\pm (1$ digital sample period, 2.5 or 5 ns) \pm chan-to-chan skew (2 ns typical, 3 ns maximum)
Delay Jitter	10 ppm
RMS Jitter	0.025% screen width + 30 ps
Modes	Main, Delayed, Roll, XY
XY	
Z blanking	1.4 V blanks trace (use External trigger)
Bandwidth	Max bandwidth
Phase error @ 1 MHz	1.8 degrees

* Denotes Warranted Specifications, all others are typical. Specifications are valid after a 30-minute warm-up period and ± 10 °C from firmware calibration temperature.

Trigger System

Sources:	54621A/22A: Ch 1, 2, line, ext 54621D/22D: Ch 1, 2, line, ext, D15 - D0 54624A: Ch 1, 2, 3, 4, line, ext
Modes	Auto, Auto level, Triggered (normal), Single
Holdoff Time	~60 ns to 10 seconds
Selections	Edge, Pattern, Pulse Width, CAN, Duration, I ² C, LIN, Sequence, SPI, TV, USB
Edge	Trigger on a rising or falling edge of any source.
Pattern	Trigger on a pattern of high, low, and don't care levels and a rising or falling edge established across any of the sources. The analog channel's high or low level is defined by that channel's trigger level.
Pulse Width	Trigger when a positive- or negative-going pulse is less than, greater than, or within a specified range on any of the source channels. Minimum pulse width setting: 5 ns Maximum pulse width setting: 10 s
CAN	Trigger on CAN (Controller Area Network) version 2.0A and 2.0B signals. It can trigger on the Start of Frame bit of a data frame, a remote transfer request frame, or an overload frame.
Duration	Trigger on a multi-channel pattern whose time duration is less than a value, greater than a value, greater than a time value with a timeout value, or inside or outside of a set of time values. Minimum duration setting: 5 ns Maximum duration setting: 10 s
I ² C	Trigger on I ² C (Inter-IC bus) serial protocol at a start/stop condition, a restart, a missing acknowledge, or user defined frame with address and/or data values. Also trigger on Missing Acknowledge, Restart, EEPROM read, and 10-bit write.
LIN	Trigger on LIN (Local Interconnect Network) sync break at beginning of message frame.
Sequence	Find event A, trigger on event B, with option to reset on event C or time delay.
SPI	Trigger on SPI (Serial Peripheral Interface) a data pattern during a specific framing period. Support positive and negative Chip Select framing as well as clock Idle framing and user-specified number of bits per frame.
USB	Trigger on USB (Universal Serial Bus) Start of Packet, End of Packet, Reset Complete, Enter Suspend, or Exit Suspend on the differential USB data lines. USB low speed and high speed are supported.
TV	Trigger on any analog channel for NTSC, PAL, PAL-M, or SECAM broadcast standards on either positive or negative composite video signals. Modes supported include Field 1, Field 2, or both, all lines, or any line within a field. Also supports triggering on non-interlaced fields. TV trigger sensitivity: 0.5 division of synch signal.
Autoscale	Finds and displays all active analog and digital (for 54621D/54622D) channels, sets edge trigger mode on highest numbered channel, sets vertical sensitivity on analog channels and thresholds on digital channels, time base to display ~1.8 periods. Requires minimum voltage >10 mVpp, 0.5% duty cycle and minimum frequency >50 Hz.

Performance Characteristics
Agilent 54620-series Performance Characteristics

* Denotes Warranted Specifications, all others are typical. Specifications are valid after a 30-minute warm-up period and ± 10 °C from firmware calibration temperature.

Analog Channel Triggering

Range (Internal)	± 6 div from center screen
Sensitivity*	Greater of 0.35 div or 2.5 mV
Coupling	AC (~3.5 Hz), DC, noise reject, HF reject and LF reject (~ 50 kHz)

Digital (D15 - D0) Channel Triggering (54621D and 5462 2D)

Threshold Range (used defined)	± 8.0 V in 10 mV increments
Threshold Accuracy*	$\pm(100$ mV + 3% of threshold setting)
Predefined Thresholds	TTL = 1.4 V, CMOS = 2.5 V, ECL = -1.3 V

External (EXT) Triggering

Input Resistance	1 M Ω $\pm 3\%$
Input Impedance	~ 14 pF
Maximum Input	 CAT I 300 Vrms, 400 Vpk CAT II 100 Vrms, 400 Vpk with 10074C 10:1 probe: CAT I 500 Vpk, CAT II 400 Vpk
Range	± 10 V
Sensitivity	dc to 25 MHz, < 75 mV 25 MHz to max bandwidth, < 150 mV
Coupling	AC (~ 3.5 Hz), DC, noise reject, HF reject and LF reject (~ 50 kHz)
Probe ID (Agilent/HP & Tek Compatible)	Auto probe sense for 54621A/22A

* Denotes Warranted Specifications, all others are typical. Specifications are valid after a 30-minute warm-up period and ± 10 °C from firmware calibration temperature.

Display System

Display	7-inch raster monochrome CRT
Throughput of Analog Channels	25 million gray scale vectors/sec per channel
Resolution	255 vertical by 1000 horizontal points (waveform area) 32 levels of gray scale
Controls	Waveform intensity on front panel Vectors on/off; infinite persistence on/off 8 x 10 grid with continuous intensity control
Built-in Help System	Key-specific help in 11 languages displayed by pressing and holding key or softkey of interest
Real Time Clock	Time and date (user setable)

Measurement Features

Automatic Measurements	Measurements are continuously updated Cursors track current measurement
Voltage (analog channels only)	Peak-to-Peak, Maximum, Minimum, Average, Amplitude, Top, Base, Overshoot, Preshoot, RMS (DC)
Time	Frequency, Period, + Width, - Width, and Duty Cycle on any channels. Rise time, Fall time, X at Max (Time at max volts), X at Min (Time at min volts), Delay, and Phase on analog channels only.
Counter	Built-in 5-digit frequency counter on any channel. Counts up to 125 MHz
Threshold Definition	Variable by percent and absolute value; 10%, 50%, 90% default for time measurements
Cursors	Manually or automatically placed readout of Horizontal (X, ΔX , $1/\Delta X$) and Vertical (Y, ΔY). Additionally digital or analog channels can be displayed as binary or hex values
Waveform Math	1-2, 1*2, FFT, differentiate, integrate. Source of FFT: differentiate, integrate, analog channels 1 or 2 (or 3 or 4 for 54624A), 1-2, 1+2, 1*2

Performance Characteristics

Agilent 54620-series Performance Characteristics

* Denotes Warranted Specifications, all others are typical. Specifications are valid after a 30-minute warm-up period and ± 10 °C from firmware calibration temperature.

FFT

Points	Fixed at 2048 points
Source of FFT	Analog channels 1 or 2 (or 3 or 4 for 54624A), 1+2, 1-2, 1*2
Window	Rectangular, Flattop, Hanning
Noise Floor	-70 to -100 dB depending on averaging
Amplitude Display	In dBV
Frequency Resolution:	0.097656/(time per div)
Maximum Frequency	102.4/(time per div)

Storage

Save/Recall (non-volatile)	3 setups and traces can be saved and recalled internally
Floppy Disk	3.5" 1.44 MB double density
Image formats	TIF, BMP
Data formats	X and Y (time/voltage) values in CSV format
Trace/setup formats	Recalled

I/O

RS-232 (serial) standard port	1 port; XON or DTR; 8 data bits; 1 stop bits; parity=none; 9600, 19200, 38400, 57600 baud rates
Parallel standard port	Printer support
Printer Compatibility	HP DeskJet, HP LaserJet with HP PCL 3 or greater compatibility Compatibility— black and white @150x150 dpi gray scale @ 600x600 dpi Epson—black and white @180x180 dpi Seiko—DPU-414 black and white
Optional GPIB Interface Module	Fully programmable with IEEE488.2 compliance Typical GPIB throughput of 20 measurements or twenty 2000-point records per second.

* Denotes Warranted Specifications, all others are typical. Specifications are valid after a 30-minute warm-up period and ± 10 °C from firmware calibration temperature.

General Characteristics

Physical:	
Size	32.26 cm wide x 17.27 cm high x 31.75 cm deep (without handle)
Weight	6.35 kgs (14 lbs)
Calibrator Output	Frequency ~1.2 kHz; Amplitude ~5 V
Trigger Out	0 to 5 V with 50 Ω source impedance; delay ~ 55 ns
Printer Power	7.2 to 9.2 V, 1 A
Kensington lock	Connection on rear panel for security

Power Requirements

Line Voltage Range	100 - 240 VAC $\pm 10\%$, CAT II, automatic selection
Line Frequency	47 to 440 Hz
Power Usage	100 W max

Environmental Characteristics

Ambient Temperature	Operating -10 °C to +55 °C Non-operating -51 °C to +71 °C
Humidity	Operating 95% RH at 40 °C for 24 hr Non-operating 90% RH at 65 °C for 24 hr
Altitude	Operating to 4,570 m (15,000 ft) Non-operating to 15,244 m (50,000 ft)
Vibration	HP/Agilent class B1 and MIL-PRF-28800F Class 3 random
Shock	HP/Agilent class B1 and MIL-PRF-28800F (operating 30 g, 1/2 sine, 11-ms duration, 3 shocks/axis along major axis. Total of 18 shocks)
Pollution degree2	Normally only dry non-conductive pollution occurs. Occasionally a temporary conductivity caused by condensation must be expected.
Indoor use only	This instrument is rated for indoor use only

Installation categories

CAT I:	Mains isolated
CAT II:	Line voltage in appliance and to wall outlet

Agilent 54620-series Performance Characteristics

Agilent 54640-series Performance Characteristics

* Denotes Warranted Specifications, all others are typical. Specifications are valid after a 30-minute warm-up period and ± 10 °C from firmware calibration temperature.

Acquisition: Analog Channels

Max Sample rate	2 GSa/s interleaved, 1 GSa/s each channel
Max Memory Depth	8 MB interleaved, 4 MB each channel
Vertical Resolution	8 bits
Peak Detection	1 ns @ max sample rate
Averages	selectable from 2, 4, 8, 16, 32, 64 ...to 16383
High Resolution Mode	12 bits of resolution when ≥ 100 us/div, average mode with average = 1
Filter:	Sinx/x interpolation (single shot BW = sample rate/4 or bandwidth of scope, whichever is less) with vectors on.

Acquisition: Digital Channels (on 54641D and 54642D only)

Max Sample Rate	1 GSa/s
Max Memory Depth	4 MB
Vertical Resolution	1 bit
Glitch Detection (min pulse width)	5 ns

Performance Characteristics
Agilent 54640-series Performance Characteristics

* Denotes Warranted Specifications, all others are typical. Specifications are valid after a 30-minute warm-up period and ± 10 °C from firmware calibration temperature.

Vertical System: Analog Channels

Analog channels	Ch1 and 2 simultaneous acquisition
Bandwidth (-3dB)*	54641A/41D: dc to 350 MHz 54642A/42D: dc to 500 MHz
ac coupled	54641A/41D: 3.5 Hz to 350 MHz 54642A/42D: 3.5 Hz to 500 MHz
Calculated rise time (= 0.35/bandwidth)	54641A/41D: ~1.0 ns 54642A/42D: ~700 ps
Single Shot Bandwidth	54641A/41D: 350 MHz maximum 54642A/42D: 500 MHz maximum
Range ¹	2 mV/div to 5 V/div
Maximum Input	 CAT I 300 Vrms, 400 Vpk CAT II 100 Vrms, 400 Vpk with 10073C 10:1 probe: CAT I 500 Vpk, CAT II 400 Vpk 5 Vrms with 50-ohm input
Offset Range	± 5 V on ranges <10 mV/div ± 20 V on ranges 10 mV/div to 200 mV/div ± 75 V on ranges >200 mV/div
Dynamic Range	Lesser of ± 8 div or ± 32 V
Input Resistance	1 M Ω $\pm 1\%$, 50-ohm selectable
Input Capacitance	~ 13 pF
Coupling	ac, dc
BW Limit	~ 25 MHz selectable
Channel-to-Channel Isolation (with channels at same V/div)	DC to max bandwidth > 40 dB
Probes	10:1 10073C shipped standard for each analog channel
Probe ID (Agilent/HP & Tek Compatible)	Auto probe sense

¹ 2 mV/div is a magnification of 4 mV/div setting. For vertical accuracy calculations, use full scale of 32 mV for 2 mV/div sensitivity setting.

* Denotes Warranted Specifications, all others are typical. Specifications are valid after a 30-minute warm-up period and ± 10 °C from firmware calibration temperature.

Vertical System: Analog Channels (continued)

ESD Tolerance	± 2 kV
Noise Peak-to-Peak	3% full scale or 3 mV, whichever is greater
Common Mode Rejection Ratio	20 dB @ 50 MHz
DC Vertical Gain Accuracy* ¹	$\pm 2.0\%$ full scale
DC Vertical Offset Accuracy	≤ 200 mV/div: ± 0.1 div ± 2.0 mV $\pm 0.5\%$ offset > 200 mV/div: ± 0.1 div ± 2.0 mV $\pm 1.5\%$ offset value
Single Cursor Accuracy ¹	$\pm \{ \text{DC Vertical Gain Accuracy} + \text{DC Vertical Offset Accuracy} + 0.2\% \text{ full scale } (\sim 1/2 \text{ LSB}) \}$ <i>Example: For 50 mV signal, scope set to 10 mV/div (80 mV full scale), 5 mV offset, accuracy = $\pm \{ 2.0\%(80\text{mV}) + 0.1 (10 \text{ mV}) + 2.0 \text{ mV} + 0.5\% (5 \text{ mV}) + 0.2\%(80 \text{ mV}) \} = \pm 4.78 \text{ mV}$</i>
Dual Cursor Accuracy* ¹	$\pm \{ \text{DC Vertical Gain Accuracy} + 0.4\% \text{ full scale } (\sim 1 \text{ LSB}) \}$ <i>Example: For 50 mV signal, scope set to 10 mV/div (80 mV full scale), 5 mV offset, accuracy = $\pm \{ 2.0\%(80 \text{ mV}) + 0.4\%(80 \text{ mV}) \} = \pm 1.92 \text{ mV}$</i>

¹ 2 mV/div is a magnification of 4 mV/div setting. For vertical accuracy calculations, use full scale of 32 mV for 1 mV/div sensitivity setting.

Vertical System: Digital Channels (54641D and 54642D only)

Number of Channels	16 Digital – labeled D15 – D0
Threshold Groupings	Pod 1: D7 – D0 Pod 2: D15 – D8
Threshold Selections	TTL, CMOS, ECL, user-definable (selectable by pod)
User-Defined Threshold Range	± 8.0 V in 10 mV increments
Maximum Input Voltage 	± 40 V peak CAT I
Threshold Accuracy*	$\pm (100 \text{ mV} + 3\% \text{ of threshold setting})$
Input Dynamic Range	± 10 V about threshold
Minimum Input Voltage Swing	500 mV peak-to-peak
Input Capacitance	~ 8 pF
Input Resistance	100 k Ω $\pm 2\%$ at probe tip
Channel-to-Channel Skew	2 ns typical, 3 ns maximum

Performance Characteristics
Agilent 54640-series Performance Characteristics

* Denotes Warranted Specifications, all others are typical. Specifications are valid after a 30-minute warm-up period and ± 10 °C from firmware calibration temperature.

Horizontal

Range	1 ns/div to 50 s/div
Resolution	2.5 ps
Vernier	1-2-5 increments when off, 25 minor increments between major settings when on
Reference Positions	Left, Center, Right
Delay Range	
Pre-trigger (negative delay)	Greater of 1 screen width or 1 ms
Post-trigger (positive delay)	500 seconds
Analog Delta-t Accuracy	
Same Channel*	$\pm 0.005\%$ reading $\pm 0.1\%$ screen width ± 20 ps <i>Example:</i> for signal with pulse width of 10 us, scope set to 5 us/div (50 us screen width), delta-t accuracy = $\pm\{.005\%(10\text{ us}) + 0.1\% (50\text{ us}) + 20\text{ ps}\} = 50.52\text{ ns}$
Channel-to-Channel	$\pm 0.005\%$ reading $\pm 0.1\%$ screen width ± 40 ps
Digital Delta-t Accuracy	(non-Vernier settings)
Same Channel	$\pm 0.005\%$ reading $\pm 0.1\%$ screen width $\pm (1\text{ digital sample period}, 1\text{ ns})$ <i>Example:</i> for signal with pulse width of 10 us, scope set to 5 us/div (50 us screen width), and single pod active (1 GSa/s), delta-t accuracy = $\pm\{.005\%(10\text{ us}) + 0.1\% (50\text{ us}) + 1\text{ ns}\}$ = 51.5 ns
Channel-to-Channel	$\pm 0.005\%$ reading $\pm 0.1\%$ screen width $\pm (1\text{ digital sample period}) \pm (\text{chan-to-chan skew})$
Delay Jitter	10 ppm
RMS Jitter	0.025% screen width + 30 ps
Modes	Main, Delayed, Roll, XY
XY	
Bandwidth	Max bandwidth
Phase error @ 1 MHz	1.8 degrees

* Denotes Warranted Specifications, all others are typical. Specifications are valid after a 30-minute warm-up period and ± 10 °C from firmware calibration temperature.

Trigger System

Sources:	54641A/42A: Ch 1, 2, line, ext 54641D/42D: Ch 1, 2, line, ext, D15 - D0
Modes	Auto, Triggered (normal), Single
Holdoff Time	~60 ns to 10 seconds
Selections	Edge, Pattern, Pulse Width, CAN, Duration, I ² C, LIN, Sequence, SPI, TV, USB
Edge	Trigger on a rising or falling edge of any source.
Pattern	Trigger on a pattern of high, low, and don't care levels and a rising or falling edge established across any of the sources. The analog channel's high or low level is defined by that channel's trigger level.
Pulse Width	Trigger when a positive- or negative-going pulse is less than, greater than, or within a specified range on any of the source channels. Minimum pulse width setting: 2 ns Maximum pulse width setting: 10 s
CAN	Trigger on CAN (Controller Area Network) version 2.0A and 2.0B signals. It can trigger on the Start of Frame bit of a data frame, a remote transfer request frame, or an overload frame.
Duration	Trigger on a multi-channel pattern whose time duration is less than a value, greater than a value, greater than a time value with a timeout value, or inside or outside of a set of time values. Minimum duration setting: 5 ns Maximum duration setting: 10 s
I ² C	Trigger on I ² C (Inter-IC bus) serial protocol at a start/stop condition, a restart, a missing acknowledge, or user defined frame with address and/or data values. Also trigger on Missing Acknowledge, Restart, EEPROM read, and 10-bit write.
LIN	Trigger on LIN (Local Interconnect Network) sync break at beginning of message frame.
Sequence	Find event A, trigger on event B, with option to reset on event C or time delay.
SPI	Trigger on SPI (Serial Peripheral Interface) a data pattern during a specific framing period. Support positive and negative Chip Select framing as well as clock Idle framing and user-specified number of bits per frame.
USB	Trigger on USB (Universal Serial Bus) Start of Packet, End of Packet, Reset Complete, Enter Suspend, or Exit Suspend on the differential USB data lines. USB low speed and high speed are supported.
TV	Trigger on any analog channel for NTSC, PAL, PAL-M, or SECAM broadcast standards on either positive or negative composite video signals. Modes supported include Field 1, Field 2, or both, all lines, or any line within a field. Also supports triggering on non-interlaced fields. TV trigger sensitivity: 0.5 division of synch signal.
Autoscale	Finds and displays all active analog and digital (for 54641D/54642D) channels, sets edge trigger mode on highest numbered channel, sets vertical sensitivity on analog channels and thresholds on digital channels, time base to display ~1.8 periods. Requires minimum voltage >10 mVpp, 0.5% duty cycle and minimum frequency >50 Hz.

Performance Characteristics
Agilent 54640-series Performance Characteristics

* Denotes Warranted Specifications, all others are typical. Specifications are valid after a 30-minute warm-up period and $\pm 10^\circ\text{C}$ from firmware calibration temperature.

Analog Channel Triggering

Range (Internal)	± 6 div
Sensitivity*	< 10 mV/div: Greater of 1 div or 5 mV ≥ 10 mV/div: 0.6 div
Coupling	ac (~ 10 Hz), dc, noise reject, HF reject and LF reject (~ 50 kHz)

Digital (D15 - D0) Channel Triggering (54641D and 54642D)

Threshold Range (used defined)	± 8.0 V in 10 mV increments
Threshold Accuracy*	$\pm (100$ mV + 3% of threshold setting)
Predefined Thresholds	TTL = 1.4 V, CMOS = 2.5 V, ECL = -1.3 V

External (EXT) Triggering

Input Resistance	1 M Ω $\pm 3\%$ or 50-Ohm
Input Impedance	~ 13 pF
Maximum Input	 CAT I 300 Vrms, 400 Vpk CAT II 100 Vrms, 400 Vpk with 10073C 10:1 probe: CAT I 500 Vpk, CAT II 400 Vpk 5 Vrms with 50-ohm input
Range	DC coupling: trigger level ± 8 V AC coupling/LF reject: AC input minus trigger level not to exceed ± 8 V
Sensitivity	DC to 100 MHz, < 100 mV 100 MHz to max bandwidth, < 200 mV
Coupling	ac (~ 3.5 Hz), dc, noise reject, HF reject and LF reject (~ 50 kHz)
Probe Id (Agilent/HP & Tek compatible)	Auto probe sense for 54641A/42A

* Denotes Warranted Specifications, all others are typical. Specifications are valid after a 30-minute warm-up period and ± 10 °C from firmware calibration temperature.

Display System

Display	7-inch raster monochrome CRT
Throughput of Analog Channels	25 million gray scale vectors/sec per channel
Resolution	255 vertical by 1000 horizontal points (waveform area) 32 levels of gray scale
Controls	Waveform intensity on front panel Vectors on/off; infinite persistence on/off 8 x 10 grid with continuous intensity control
Built-in Help System	Key-specific help in 11 languages displayed by pressing and holding key or softkey of interest
Real Time Clock	Time and date (user setable)

Measurement Features

Automatic Measurements	Measurements are continuously updated Cursors track current measurement
Voltage (analog channels only)	Peak-to-Peak, Maximum, Minimum, Average, Amplitude, Top, Base, Overshoot, Preshoot, RMS (dc)
Time	Frequency, Period, + Width, - Width, and Duty Cycle on any channels. Rise time, Fall time, X at Max (Time at max volts), X at Min (Time at min volts), Delay, and Phase on analog channels only.
Counter	Built-in 5-digit frequency counter on any channel. Counts up to 125 MHz.
Threshold Definition	Variable by percent and absolute value; 10%, 50%, 90% default for time measurements
Cursors	Manually or automatically placed readout of Horizontal (X, ΔX , $1/\Delta X$) and Vertical (Y, ΔY). Additionally digital or analog channels can be displayed as binary or hex values
Waveform Math	1-2, 1*2, FFT, differentiate, integrate. Source of FFT: differentiate, integrate, analog channels 1 or 2, 1-2, 1+2, 1*2

Performance Characteristics
Agilent 54640-series Performance Characteristics

* Denotes Warranted Specifications, all others are typical. Specifications are valid after a 30-minute warm-up period and ± 10 °C from firmware calibration temperature.

FFT

Points	Fixed at 2048 points
Source of FFT	Analog channels 1 or 2, 1+2, 1-2, 1*2
Window	Rectangular, Flattop, Hanning
Noise Floor	-70 to -100 dB depending on averaging
Amplitude Display	In dBV, dBm @ 50 ohm
Frequency Resolution:	0.097656/(time per div)
Maximum Frequency	102.4/(time per div)

Storage

Save/Recall (non-volatile)	4 setups and traces can be saved and recalled internally
Floppy Disk	3.5" 1.44 MB double density
Image formats	TIF, BMP
Data formats	X and Y (time/voltage) values in CSV format
Trace/setup formats	Recalled

I/O

RS-232 (serial) standard port	1 port; XON or DTR; 8 data bits; 1 stop bits; parity=none; 9600, 19200, 38400, 57600 baud rates
Parallel standard port	Printer support
Printer Compatibility	HP DeskJet, HP LaserJet with HP PCL 3 or greater compatibility Compatibility— black and white @150x150 dpi gray scale @ 600x600 dpi Epson—black and white @180x180 dpi Seiko—DPU-414 black and white
Optional GPIB Interface Module	Fully programmable with IEEE488.2 compliance Typical GPIB throughput of 20 measurements or twenty 2000-point records per second.

* Denotes Warranted Specifications, all others are typical. Specifications are valid after a 30-minute warm-up period and ± 10 °C from firmware calibration temperature.

General Characteristics

Physical:	
Size	32.26 cm wide x 17.27 cm high x 31.75 cm deep (without handle)
Weight	6.82 kgs (15 lbs)
Calibrator Output	Frequency ~2 kHz; Amplitude ~5 V
Trigger Out	0 to 5 V with 50 Ω source impedance; delay ~ 22 ns
Printer Power	7.2 to 9.2 V, 1 A
Kensington lock	Connection on rear panel for security

Power Requirements

Line Voltage Range	100 - 240 VAC, 50/60 Hz, CAT II, automatic selection 100 - 132 VAC, 440 Hz, CAT II, automatic selection
Line Frequency	50/60 Hz, 100 - 240 VAC 440 Hz, 100 - 132 VAC
Power Usage	110 W max

Environmental Characteristics

Ambient Temperature	Operating -10 °C to +55 °C Non-operating -51 °C to +71 °C
Humidity	Operating 95% RH at 40 °C for 24 hr Non-operating 90% RH at 65 °C for 24 hr
Altitude	Operating to 4,570 m (15,000 ft) Non-operating to 15,244 m (50,000 ft)
Vibration	HP/Agilent class B1 and MIL-PRF-28800F Class 3 random
Shock	HP/Agilent class B1 and MIL-PRF-28800F (operating 30 g, 1/2 sine, 11-ms duration, 3 shocks/axis along major axis. Total of 18 shocks)
Pollution degree2	Normally only dry non-conductive pollution occurs. Occasionally a temporary conductivity caused by condensation must be expected.
Indoor use only	This instrument is rated for indoor use only

Installation categories	CAT I: Mains isolated CAT II: Line voltage in appliance and to wall outlet
--------------------------------	---

Index

Symbols

- (-)Width measurement 5-43
- (+)Width measurement 5-43

Numerics

- 1*2 math function 5-19
- 1-2 math function 5-20

A

- about oscilloscope 6-15
- AC channel coupling 4-8
- accessories 1-5, 1-9
- acquire 2-3, 5-8
- acquiring data 4-26
- acquisition memory 3-3
- acquisition mode 4-17
 - average 4-19
 - normal 4-18
 - peak detect 4-18
 - realtime 4-20
- activity indicator 4-33
- address, GPIB 6-9
- adjust the handle 1-12
- aliasing, FFT 5-25
- Amplitude measurement 5-48
- analog channel
 - probe attenuation 4-10
- analog channel setup 4-7
- analog channels 2-12
- analog probes 1-15
- application software updates 6-5
- attenuation factor 2-17
- attenuation, probe 3-10, 4-10
- auto level trigger mode 3-4
- auto trigger mode 3-4
- automatic measurements 2-23, 5-37
- AutoProbe 3-10, 4-9
 - analog channel input 4-10
 - external trigger 3-10
- Autosave traces and setups 4-49
- Autoscale 2-12, 2-13, 2-14
- auto-single 4-28
- average acquire mode 2-4, 4-19
- Average measurement 5-48
- averaging 5-8

B

- bandwidth limit 4-9
- Base measurement 5-48
- baud rate 6-9
- binary cursors 5-32
- bits, SPI trigger 3-38
- BMP file 4-53, 6-6

C

- CAN trigger 3-19
- CAN Trigger Module 3-19
- capturing data 5-3
- Center, FFT 5-27
- channel
 - analog 4-7
 - bandwidth limit 4-9
 - coupling 4-8
 - invert 4-9
 - position 4-8
 - probe units 4-10
 - skew 4-10
 - vernier 4-9
 - vertical sensitivity 4-8
- cleaning 1-11
- cleaning the instrument 15
- clear display 4-21, 4-31, 5-11
- clock 6-11
- CMOS threshold 4-37
- comma-separated variable file 4-53, 6-6
- compensating your probe 1-16
- configure printer 6-6
- controls, front panel 2-7
- conventions 1-24, 2-2
- Counter measurement 5-42
- coupling, channel 4-8
- CSV file 4-53, 6-6
- CSV length 6-7
- cursor measurements 2-22, 5-31

D

- d/dt math function 5-21
- data, capturing 5-3
- DC channel coupling 4-8
- deep memory 4-4
- default configuration 2-15
- default library 4-47, 6-16
- default setup 2-15, 4-54
- delay knob 4-13
- delay markers 4-14
- Delay measurement 5-45
- delay time indicator 4-12
- delayed mode 4-14
- delayed sweep 2-6, 2-21, 5-4
- delete file, floppy 6-8
- DeskJet printer 6-6
- differentiate math function 5-21
- digital channels 2-10, 2-13, 2-18
 - Autoscale 4-32
 - display 2-17, 4-34
 - logic threshold 4-37
 - on/off 4-35
 - position 4-34
 - probing 4-38
 - size 4-36
- digital display, interpreting 4-33
- digital probe kit 1-5
- digital probes 1-17
- digital probing 4-38
- display 2-11
 - area 2-11
 - intensity 1-14
 - interpreting 2-11
 - measurement line 2-11
 - modes 4-21
 - softkeys 2-11
 - status line 2-11
 - update rate 4-6
- duration trigger 3-21
- Duty cycle measurement 5-42

E

ECL threshold 4-37
edge triggering 3-12
EEPROM data read, I2C trigger 3-26
Entry knob 1-24, 2-2
Epson printer 6-6
erase display 4-31
expand about 2-17, 4-8, 6-16
external trigger
 edge source 3-13
 input impedance 3-10
 probe attenuation 3-10
 probe settings 3-9
 probe units 3-10

F

factory setup, default 4-54
Fall time measurement 5-43
FFT measurements 5-25
FFT window 5-28
Flat top window 5-28
floppy disk 6-8
form feed, printer 6-7
frame trigger, I2C 3-26
Frequency measurement 5-42
front-panel 2-7
front-panel cover 1-5
front-panel overview 2-1

G

getting started 1-24
glitch trigger 3-14
GPIO 6-9
 address 6-9
grabber 1-18, 1-19
graticule 2-24
graticule intensity 4-21
gray scale printing 6-7
grid 2-24
grid intensity 4-21
ground channel coupling 4-8
ground level 4-8

H

handle 1-12
handshake 6-9
Hanning window 5-28
hex cursors 5-32
HF Reject 3-6, 5-6
high-resolution mode 2-4, 4-19, 5-9
holdoff 3-7
Horizontal section 4-11
horizontal vernier 4-12
hysteresis, trigger 5-7

I

I/O port configuration 6-9
I2C trigger 3-24
impedance
 external trigger 3-10
indeterminate state 5-32
infinite persistence 4-21, 4-25, 4-30, 5-10
input impedance
 channel input 4-9
 external trigger 3-10
input voltage 1-15, 3-9
Integrate math function 5-23
intensity 1-14, 4-21
intensity knob 2-24
invert 4-9

L

label list 4-46
labels 4-42
languages
 Quick Help 1-25, 6-3
 updates 1-26, 6-3
LaserJet printer 6-6
LF reject 5-7
library, default labels 4-47
library, labels 4-44
LIN trigger 3-29
line trigger 3-13
link 1-24
load file, floppy 6-8
loading language 1-27, 6-4
localized language updates 1-26, 6-3
logic threshold 4-37

M

main horizontal mode 4-11
markers, delay 4-14
math
 1*2 5-19
 1-2 5-20
 differentiate 5-21
 FFT 5-25
 functions 5-17
 integrate 5-23
 measurements 5-47
 multiply 5-19
 offset 5-18
 scale 5-18
 subtract 5-20
 units 5-18
Maximum measurement 5-48
measurement definitions 5-42
measurement line 2-11
measurement thresholds 5-39
measurements 2-23, 5-1
MegaZoom 4-3, 4-5
MegaZoom concepts 4-1
memory depth 4-27
memory, deep 4-4
Minimum measurement 5-48
missing acknowledge condition, I2C trigger 3-25
mixed-signal, configure 4-32
Mode/Coupling key, trigger 3-3
Multiply math function 5-19

N

N2758A CAN Trigger Module 3-19
new label 4-45
noise reject 3-6
normal acquire mode 2-3, 4-18
normal cursors 5-32
normal trigger mode 3-5

O

options 1-8, 6-16
Overshoot measurement 5-51

P

pan and zoom 4-23, 4-24
parallel printer port 6-6
pattern
 duration trigger 3-21
 pattern trigger 3-17
 SPI trigger 3-38
pattern trigger 3-17
peak detect acquire mode 2-4, 4-18, 5-10
Peak-peak measurement 5-48
performance characteristics 7-1
 54620-series 7-3
 54640-series 7-13
Period measurement 5-42
Phase measurement 5-46
position 2-16
position, analog 4-8
post-processing 2-6
pouch 1-5
power switch 1-13
power-on 1-13
predefined labels 4-44
Preset, FFT 5-27
Preshoot measurement 5-50
print 2-24, 4-53
print configuration 6-6
print gray scale 6-7
print scale factors 6-7
printer form feed 6-7
printer port 6-6
printer, connecting to 1-21
printing screen images 4-53
probe attenuation 3-10, 4-10
probe factor 2-17
probe units 3-10, 4-10
probes
 analog 1-15
 compensating 1-16
 digital 1-17
pulse polarity 3-15
pulse width trigger 3-14

Q

qualifier 3-15
Quick Help 1-25, 6-3
Quick Meas 2-23, 5-37
Quick Print 2-24, 4-53

R

random noise 5-6
realtime acquire mode 2-5, 4-20
recall traces and setup 4-48
record length 4-27
Rectangular window 5-28
restart condition, I2C trigger 3-25
Rise time measurement 5-43
RMS measurement 5-49
roll mode 4-16, 5-12
RS-232 6-9
 baud rate 6-9
 cable 1-21, 6-10
 port 6-10
Run/Stop 2-3, 2-20, 4-25

S

sample rate 2-5, 4-20, 5-9
save traces and setups 4-48
Save/Recall 4-48
saver, screen 6-12
scale factors, print 6-7
scaling 2-16
SCL, I2C trigger 3-24
screen saver 6-12
SDA 3-24
SDA, I2C trigger 3-25
Seiko printer 6-6
Self Test, service 6-15
sequence trigger 3-31
serial clock, I2C trigger 3-24
serial data 3-24
serial data, I2C trigger 3-25
service functions 6-14
setup, default 2-15, 4-54

Single 2-3, 2-20, 4-25
single event 4-29
single trace 4-28
size 4-36
skew, analog channel 4-10
slope 3-12
slope trigger 3-12
softkeys 1-24, 2-2, 2-11
software updates 6-5
Span, FFT 5-27
spectral leakage, FFT 5-26
SPI trigger 3-37
stage, sequence 3-33
start acquisition 2-20
start condition, I2C 3-25
startup 1-23
status line 2-11
status, User Cal 6-15
stop acquisition 2-20
stop condition, I2C 3-25
Subtract math function 5-20
sweep speed vernier 4-12
symbols 1-24
sync polarity, TV trigger 3-43

T

threshold
 analog channel measurements 5-39
 digital channels 3-14, 3-17, 3-21,
 4-37
TIF file 4-53, 6-6
time base 2-19
time measurements 5-41
time reference 2-19, 4-12
time reference indicator 4-12
timebase 4-11
Top measurement 5-49

trigger

- coupling 3-6
- external 3-9
- HF Reject 3-6
- holdoff 3-7
- hysteresis 5-7
- mode 3-3
- mode/coupling 3-3
- noise reject 3-6
- slope 3-12
- source 3-12

trigger mode

- auto 3-4
- auto level 3-4
- normal 3-5

Trigger Out connector 3-54

trigger type 3-11

- CAN 3-19
- duration 3-21
- edge 3-12
- glitch 3-14
- I2C 3-24
- LIN 3-29
- pattern 3-17
- pulse width 3-14
- sequence 3-31
- slope 3-12
- SPI 3-37
- TV 3-42
- USB 3-52

triggering 3-1

TTL threshold 4-37

TV trigger 3-42

U

undo Autoscale 2-12, 2-13, 2-14

units, probe 3-10, 4-10

units,math 5-18

update rate 4-6

updates

- application software 6-5
- languages 1-26, 6-3

USB trigger 3-52

User Cal, service 6-14

User-defined threshold 4-37

utilities 6-2

V

vectors 2-5, 4-22

vernier 2-19

vernier, channel 4-9

vernier, sweep speed 4-12

vertical 4-7

vertical expansion 4-8

vertical scaling 2-16

vertical sensitivity 4-8

voltage measurements 5-47

W

waveform intensity 4-21

Width - measurement 5-43

Width + measurement 5-43

Window, FFT 5-28

X

X and Y cursors 5-33

X at Max measurement 5-43

X at Max on FFT 5-41

X at Min measurement 5-44

XY mode 4-16, 5-13

Y

Y and X cursors 5-33

Z

Z-axis blanking 5-15

zoom and pan 4-23, 4-24

DECLARATION OF CONFORMITY

According to ISO/IEC Guide 22 and CEN/CENELEC EN 45014

Manufacturer's Name: Agilent Technologies, Inc.
Manufacturer's Address: Garden of the Gods Road
Colorado Springs, Colorado
80907 U.S.A.

Declares, that the product

Product Name: Digitizing Oscilloscope
Model Number(s): 54621A/D, 54622A/D, and 54624A/AN
Product Option(s): All options based on the above

Is in conformity with:

EMC: IEC 61326-1:1997+A1:1998 / EN 61326-1:1997+A1:1998
CCISPR 11:1990/EN 55011:1991– Group 1 Class A^[1]
IEC 61000-4-2:1995+A1:1998 / EN 61000-4-2:1995 (ESD 4kV CD, 8kV AD)
IEC 61000-4-3:1995/EN 61000-4-3:1995 (3V/m 80% AM)
IEC 61000-4-4:1995/EN 61000-4-4:1995 (0.5kV line-line, 1kV line-earth)
IEC 61000-4-6:1996/EN 61000-4-6:1996 (3V 80% AM, power line)
Australia/New Zealand: AS/NZS 2064.1

Safety IEC 61010-1:1990+A1:1992+A2:1995 / EN 61010-1:1993+A2:1995
Canada: CSA C22.2 No. 1010.1:1992
USA: UL 3111-1:1994

Additional Information:

The product herewith complies with the requirements of the Low Voltage Directive 73/23/EEC and the EMC Directive 89/336/EEC (including 93/68/EEC) and carries the CE-marking accordingly (European Union).

^[1] The product was tested in a typical configuration with Agilent Technologies test systems.

Date: 01/27/2000

Name

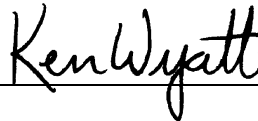

Ken Wyatt / Product Regulations Manager

For further information, please contact your local Agilent Technologies sales office, agent or distributor.

54620-series Product Regulations

EMC

IEC 61326-1:1997+A1:1998 / EN 61326-1:1997+A1:1998
CISPR 11:1990 / EN 55011:1991
IEC 61000-4-2:1995+A1:1998 / EN 61000-4-2:1995
IEC 61000-4-3:1995 / EN 61000-4-3:1995
IEC 61000-4-4:1995 / EN 61000-4-4:1995
IEC 61000-4-6:1996 / EN 61000-4-6:1996
Canada: ICES-001:1998

Performance Criteria

B
B
B
A, B (1)

Safety

IEC 61010-1:1990+A1:1992+A2:1995 / EN 61010-1:1993+A2:1995
Canada: CSA C22.2 No. 1010.1:1992

Additional Information

The product herewith complies with the requirements of the Low Voltage Directive 73/23/EEC and the EMC Directive 89/336/EEC (including 93/68/EEC) and carries the CE Marking accordingly (European Union).

Performance Criteria:

- A Pass - Normal operation, no effect.
- B Pass - Temporary degradation, self recoverable.
- C Pass - Temporary degradation, operator intervention required.
- D Fail - Not recoverable, component damage.

Notes:

- (1) 54621D/54622D = A, 54621A/54622A/54624A = B

Sound Pressure Level Less than 60 dBA

Regulatory Information for Canada

ICES/NMB-001

This ISM device complies with Canadian ICES-001.
Cet appareil ISM est conforme à la norme NMB-001 du Canada.

Regulatory Information for Australia/New Zealand

This ISM device complies with Australian/New Zealand AS/NZS 2064.1



DECLARATION OF CONFORMITY

According to ISO/IEC Guide 22 and CEN/CENELEC EN 45014

Manufacturer's Name: Agilent Technologies, Inc.
Manufacturer's Address: 1900 Garden of the Gods Road
Colorado Springs, Colorado
80907 U.S.A.

Declares, that the product

Product Name: Digitizing Oscilloscope
Model Number: 54641A
Product Options: This declaration covers all options of the above product(s).

Conforms with the following product standards:

EMC	Standard	Limit
	IEC 61326-1:1997+A1:1998 / EN 61326-1:1997+A1:1998	
	CISPR 11:1990/EN 55011:1991	Group 1 Class A ^[1]
	IEC 61000-4-2:1995+A1:1998 / EN 61000-4-2:1995	4 kV CD, 8 kV AD
	IEC 61000-4-3:1995/EN 61000-4-3:1995	3 V/m, 80-1000 MHz
	IEC 61000-4-4:1995/EN 61000-4-4:1995	0.5 kV signal lines, 1 kV power lines
	IEC 61000-4-5:1995/EN 61000-4-5:1995	0.5 kv line-line, 1 kV line-ground
	IEC 61000-4-6:1996/EN 61000-4-6:1996	3V, 0.15-80 MHz
	IEC 61000-4-11:1994/EN 61000-4-11:1994	1 cycle, 100%
	Canada: ICES-001:1998	
	Australia/New Zealand: AS/NZS 2064.1	
Safety	IEC 61010-1:1990+A1:1992+A2:1995 / EN 61010-1:1993+A2:1995	
	Canada: CSA C22.2 No. 1010.1:1992	

The product herewith complies with the requirements of the Low Voltage Directive 73/23/EEC and the EMC Directive 89/336/EEC (including 93/68/EEC) and carries the CE-marking accordingly (European Union).

^[1] The product was tested in a typical configuration with Agilent Technologies test systems.

Date: 2002-3-11

Name

Ken Wyatt / Product Regulations Manager

For further information, please contact your local Agilent Technologies sales office, agent or distributor.

54641A Product Regulations

EMC

Performance Criteria¹

IEC 61326-1:1997+A1:1998 / EN 61326-1:1997+A1:1998	
CISPR 11:1990 / EN 55011:1991	
IEC 61000-4-2:1995+A1:1998 / EN 61000-4-2:1995 (4 kV CD, 8 kV AD)	B
IEC 61000-4-3:1995 / EN 61000-4-3:1995 (3V/m, 80-1000 MHz)	B
IEC 61000-4-4:1995 / EN 61000-4-4:1995 (0.5 kV signal lines, 1 kV power lines)	A
IEC 61000-4-5:1995/EN 61000-4-5:1995 (0.5 kv line-line, 1 kV line-ground)	B
IEC 61000-4-6:1996 / EN 61000-4-6:1996 (3V, 0.15-80 MHz)	B
IEC 61000-4-11:1994/EN 61000-4-11:1994 (1 cycle, 100%)	A
Canada: ICES-001:1998	
Australia/New Zealand: AS/NZS 2064.1	

Safety

IEC 61010-1:1990+A1:1992+A2:1995 / EN 61010-1:1993+A2:1995
Canada: CSA C22.2 No. 1010.1:1992
USA: UL 3111-1:1994 {optional}

Additional Information

The product herewith complies with the requirements of the Low Voltage Directive 73/23/EEC and the EMC Directive 89/336/EEC (including 93/68/EEC) and carries the CE Marking accordingly (European Union).

¹ Performance Criteria:

- A Pass - Normal operation, no effect.
- B Pass - Temporary degradation, self recoverable.
- C Pass - Temporary degradation, operator intervention required.
- D Fail - Not recoverable, component damage.

Sound Pressure Level Less than 60 dBA

Regulatory Information for Canada

ICES/NMB-001

This ISM device complies with Canadian ICES-001.
Cet appareil ISM est conforme à la norme NMB-001 du Canada.

Regulatory Information for Australia/New Zealand

This ISM device complies with Australian/New Zealand AS/NZS 2064.1



DECLARATION OF CONFORMITY

According to ISO/IEC Guide 22 and CEN/CENELEC EN 45014

Manufacturer's Name: Agilent Technologies, Inc.
Manufacturer's Address: 1900 Garden of the Gods Road
Colorado Springs, Colorado
80907 U.S.A.

Declares, that the product

Product Name: Digitizing Oscilloscope
Model Number: 54641D
Product Options: This declaration covers all options of the above product(s).

Conforms with the following product standards:

EMC	Standard	Limit
	IEC 61326-1:1997+A1:1998 / EN 61326-1:1997+A1:1998	
	CISPR 11:1990/EN 55011:1991	Group 1 Class A ^[1]
	IEC 61000-4-2:1995+A1:1998 / EN 61000-4-2:1995	4 kV CD, 8 kV AD
	IEC 61000-4-3:1995/EN 61000-4-3:1995	3 V/m, 80-1000 MHz
	IEC 61000-4-4:1995/EN 61000-4-4:1995	0.5 kV signal lines, 1 kV power lines
	IEC 61000-4-5:1995/EN 61000-4-5:1995	0.5 kv line-line, 1 kV line-ground
	IEC 61000-4-6:1996/EN 61000-4-6:1996	3V, 0.15-80 MHz
	IEC 61000-4-11:1994/EN 61000-4-11:1994	1 cycle, 100%
	Canada: ICES-001:1998	
	Australia/New Zealand: AS/NZS 2064.1	
Safety	IEC 61010-1:1990+A1:1992+A2:1995 / EN 61010-1:1993+A2:1995	
	Canada: CSA C22.2 No. 1010.1:1992	

The product herewith complies with the requirements of the Low Voltage Directive 73/23/EEC and the EMC Directive 89/336/EEC (including 93/68/EEC) and carries the CE-marking accordingly (European Union).

[1] The product was tested in a typical configuration with Agilent Technologies test systems.

Date: 2002-3-11

Name

Ken Wyatt / Product Regulations Manager

For further information, please contact your local Agilent Technologies sales office, agent or distributor.

54641D Product Regulations

EMC

Performance Criteria¹

IEC 61326-1:1997+A1:1998 / EN 61326-1:1997+A1:1998	
CISPR 11:1990 / EN 55011:1991	
IEC 61000-4-2:1995+A1:1998 / EN 61000-4-2:1995 (4 kV CD, 8 kV AD)	B
IEC 61000-4-3:1995 / EN 61000-4-3:1995 (3V/m, 80-1000 MHz)	B
IEC 61000-4-4:1995 / EN 61000-4-4:1995 (0.5 kV signal lines, 1 kV power lines)	B
IEC 61000-4-5:1995/EN 61000-4-5:1995 (0.5 kv line-line, 1 kV line-ground)	A
IEC 61000-4-6:1996 / EN 61000-4-6:1996 (3V, 0.15-80 MHz)	B
IEC 61000-4-11:1994/EN 61000-4-11:1994 (1 cycle, 100%)	A
Canada: ICES-001:1998	
Australia/New Zealand: AS/NZS 2064.1	

Safety

IEC 61010-1:1990+A1:1992+A2:1995 / EN 61010-1:1993+A2:1995
Canada: CSA C22.2 No. 1010.1:1992
USA: UL 3111-1:1994 {optional}

Additional Information

The product herewith complies with the requirements of the Low Voltage Directive 73/23/EEC and the EMC Directive 89/336/EEC (including 93/68/EEC) and carries the CE Marking accordingly (European Union).

¹ Performance Criteria:

- A Pass - Normal operation, no effect.
- B Pass - Temporary degradation, self recoverable.
- C Pass - Temporary degradation, operator intervention required.
- D Fail - Not recoverable, component damage.

Sound Pressure Level Less than 60 dBA

Regulatory Information for Canada

ICES/NMB-001

This ISM device complies with Canadian ICES-001.
Cet appareil ISM est conforme à la norme NMB-001 du Canada.

Regulatory Information for Australia/New Zealand

This ISM device complies with Australian/New Zealand AS/NZS 2064.1



DECLARATION OF CONFORMITY

According to ISO/IEC Guide 22 and CEN/CENELEC EN 45014

Manufacturer's Name: Agilent Technologies, Inc.
Manufacturer's Address: 1900 Garden of the Gods Road
Colorado Springs, Colorado
80907 U.S.A.

Declares, that the product

Product Name: Digitizing Oscilloscope
Model Number: 54642A
Product Options: This declaration covers all options of the above product(s).

Conforms with the following product standards:

EMC	Standard	Limit
	IEC 61326-1:1997+A1:1998 / EN 61326-1:1997+A1:1998	
	CISPR 11:1990/EN 55011:1991	Group 1 Class A ^[1]
	IEC 61000-4-2:1995+A1:1998 / EN 61000-4-2:1995	4 kV CD, 8 kV AD
	IEC 61000-4-3:1995/EN 61000-4-3:1995	3 V/m, 80-1000 MHz
	IEC 61000-4-4:1995/EN 61000-4-4:1995	0.5 kV signal lines, 1 kV power lines
	IEC 61000-4-5:1995/EN 61000-4-5:1995	0.5 kv line-line, 1 kV line-ground
	IEC 61000-4-6:1996/EN 61000-4-6:1996	3V, 0.15-80 MHz
	IEC 61000-4-11:1994/EN 61000-4-11:1994	1 cycle, 100%
	Canada: ICES-001:1998	
	Australia/New Zealand: AS/NZS 2064.1	
Safety	IEC 61010-1:1990+A1:1992+A2:1995 / EN 61010-1:1993+A2:1995	
	Canada: CSA C22.2 No. 1010.1:1992	

The product herewith complies with the requirements of the Low Voltage Directive 73/23/EEC and the EMC Directive 89/336/EEC (including 93/68/EEC) and carries the CE-marking accordingly (European Union).

^[1] The product was tested in a typical configuration with Agilent Technologies test systems.

Date: 2002-3-11

Name

Ken Wyatt / Product Regulations Manager

For further information, please contact your local Agilent Technologies sales office, agent or distributor.

54642A Product Regulations

EMC

Performance Criteria¹

IEC 61326-1:1997+A1:1998 / EN 61326-1:1997+A1:1998	
CISPR 11:1990 / EN 55011:1991	
IEC 61000-4-2:1995+A1:1998 / EN 61000-4-2:1995 (4 kV CD, 8 kV AD)	B
IEC 61000-4-3:1995 / EN 61000-4-3:1995 (3V/m, 80-1000 MHz)	B
IEC 61000-4-4:1995 / EN 61000-4-4:1995 (0.5 kV signal lines, 1 kV power lines)	A
IEC 61000-4-5:1995/EN 61000-4-5:1995 (0.5 kv line-line, 1 kV line-ground)	A
IEC 61000-4-6:1996 / EN 61000-4-6:1996 (3V, 0.15-80 MHz)	A
IEC 61000-4-11:1994/EN 61000-4-11:1994 (1 cycle, 100%)	A
Canada: ICES-001:1998	
Australia/New Zealand: AS/NZS 2064.1	

Safety

IEC 61010-1:1990+A1:1992+A2:1995 / EN 61010-1:1993+A2:1995
Canada: CSA C22.2 No. 1010.1:1992
USA: UL 3111-1:1994 {optional}

Additional Information

The product herewith complies with the requirements of the Low Voltage Directive 73/23/EEC and the EMC Directive 89/336/EEC (including 93/68/EEC) and carries the CE Marking accordingly (European Union).

¹ Performance Criteria:

- A Pass - Normal operation, no effect.
- B Pass - Temporary degradation, self recoverable.
- C Pass - Temporary degradation, operator intervention required.
- D Fail - Not recoverable, component damage.

Sound Pressure Level Less than 60 dBA

Regulatory Information for Canada

ICES/NMB-001

This ISM device complies with Canadian ICES-001.
Cet appareil ISM est conforme à la norme NMB-001 du Canada.

Regulatory Information for Australia/New Zealand

This ISM device complies with Australian/New Zealand AS/NZS 2064.1



DECLARATION OF CONFORMITY

According to ISO/IEC Guide 22 and CEN/CENELEC EN 45014

Manufacturer's Name: Agilent Technologies, Inc.
Manufacturer's Address: 1900 Garden of the Gods Road
Colorado Springs, Colorado
80907 U.S.A.

Declares, that the product

Product Name: Digitizing Oscilloscope
Model Number: 54642D
Product Options: This declaration covers all options of the above product(s).

Conforms with the following product standards:

EMC	Standard	Limit
	IEC 61326-1:1997+A1:1998 / EN 61326-1:1997+A1:1998	
	CCISPR 11:1990/EN 55011:1991	Group 1 Class A ^{[1][2]}
	IEC 61000-4-2:1995+A1:1998 / EN 61000-4-2:1995	4 kV CD, 8 kV AD
	IEC 61000-4-3:1995/EN 61000-4-3:1995	3 V/m, 80-1000 MHz
	IEC 61000-4-4:1995/EN 61000-4-4:1995	0.5 kV signal lines, 1 kV power lines
	IEC 61000-4-6:1996/EN 61000-4-6:1996	3 V, 0.15-80 MHz
	Canada: ICES-001:1998	
	Australia/New Zealand: AS/NZS 2064.1	

Safety IEC 61010-1:1990+A1:1992+A2:1995 / EN 61010-1:1993+A2:1995
Canada: CSA C22.2 No. 1010.1:1992

Additional Information:

The product herewith complies with the requirements of the Low Voltage Directive 73/23/EEC and the EMC Directive 89/336/EEC (including 93/68/EEC) and carries the CE-marking accordingly (European Union).

[1] The product was tested in a typical configuration with Agilent Technologies test systems.

[2] The product meets CISPR requirements using "type test" specified in IEC 61326-1 edition 1.1, section 3.1..

Date: 02/11/2002



Name

Ken Wyatt / Product Regulations Manager

For further information, please contact your local Agilent Technologies sales office, agent or distributor.

54642D Product Regulations

EMC

IEC 61326-1:1997+A1:1998 / EN 61326-1:1997+A1:1998
CISPR 11:1990 / EN 55011:1991
IEC 61000-4-2:1995+A1:1998 / EN 61000-4-2:1995
IEC 61000-4-3:1995 / EN 61000-4-3:1995
IEC 61000-4-4:1995 / EN 61000-4-4:1995
IEC 61000-4-6:1996 / EN 61000-4-6:1996
Canada: ICES-001:1998
Australia/New Zealand: AS/NZS 2064.1

Performance Criteria¹

B
B
B
B

Safety

IEC 61010-1:1990+A1:1992+A2:1995 / EN 61010-1:1993+A2:1995
Canada: CSA C22.2 No. 1010.1:1992

Additional Information

The product herewith complies with the requirements of the Low Voltage Directive 73/23/EEC and the EMC Directive 89/336/EEC (including 93/68/EEC) and carries the CE Marking accordingly (European Union).

¹ Performance Criteria:

- A Pass - Normal operation, no effect.
- B Pass - Temporary degradation, self recoverable.
- C Pass - Temporary degradation, operator intervention required.
- D Fail - Not recoverable, component damage.

Sound Pressure Level Less than 60 dBA

Regulatory Information for Canada

ICES/NMB-001

This ISM device complies with Canadian ICES-001.
Cet appareil ISM est conforme à la norme NMB-001 du Canada.

Regulatory Information for Australia/New Zealand

This ISM device complies with Australian/New Zealand AS/NZS 2064.1

 **N10149**

Safety Notices

This apparatus has been designed and tested in accordance with IEC Publication 1010, Safety Requirements for Measuring Apparatus, and has been supplied in a safe condition. This is a Safety Class I instrument (provided with terminal for protective earthing). Before applying power, verify that the correct safety precautions are taken (see the following warnings). In addition, note the external markings on the instrument that are described under "Safety Symbols."

Warnings

- Before turning on the instrument, you must connect the protective earth terminal of the instrument to the protective conductor of the (mains) power cord. The mains plug shall only be inserted in a socket outlet provided with a protective earth contact. You must not negate the protective action by using an extension cord (power cable) without a protective conductor (grounding). Grounding one conductor of a two-conductor outlet is not sufficient protection.
- Only fuses with the required rated current, voltage, and specified type (normal blow, time delay, etc.) should be used. Do not use repaired fuses or short-circuited fuseholders. To do so could cause a shock or fire hazard.
- If you energize this instrument by an auto transformer (for voltage reduction or mains isolation), the common terminal must be connected to the earth terminal of the power source.

- Whenever it is likely that the ground protection is impaired, you must make the instrument inoperative and secure it against any unintended operation.

- Service instructions are for trained service personnel. To avoid dangerous electric shock, do not perform any service unless qualified to do so. Do not attempt internal service or adjustment unless another person, capable of rendering first aid and resuscitation, is present.

- Do not install substitute parts or perform any unauthorized modification to the instrument.

- Capacitors inside the instrument may retain a charge even if the instrument is disconnected from its source of supply.

- Do not operate the instrument in the presence of flammable gasses or fumes. Operation of any electrical instrument in such an environment constitutes a definite safety hazard.

- Do not use the instrument in a manner not specified by the manufacturer.

To clean the instrument

If the instrument requires cleaning: (1) Remove power from the instrument. (2) Clean the external surfaces of the instrument with a soft cloth dampened with a mixture of mild detergent and water. (3) Make sure that the instrument is completely dry before reconnecting it to a power source.

Safety Symbols



Instruction manual symbol: the product is marked with this symbol when it is necessary for you to refer to the instruction manual in order to protect against damage to the product..



Hazardous voltage symbol.



Earth terminal symbol: Used to indicate a circuit common connected to grounded chassis.

Notices

© Agilent Technologies, Inc.
2000-2002

No part of this manual may be reproduced in any form or by any means (including electronic storage and retrieval or translation into a foreign language) without prior agreement and written consent from Agilent Technologies, Inc. as governed by United States and international copyright laws.

Manual Part Number

54622-97036, September 2002

Print History

54622-97036, September 2002

54622-97035, April 2002

54622-97029, March 2002

54622-97014, August 2000

54622-97002, March 2000

Agilent Technologies, Inc.
1601 California Street
Palo Alto, CA 94304 USA

Restricted Rights Legend

If software is for use in the performance of a U.S. Government prime contract or subcontract, Software is delivered and licensed as "Commercial computer software" as defined in DFAR 252.227-7014 (June 1995), or as a "commercial item" as defined in FAR 2.101(a) or as "Restricted computer software" as defined in FAR 52.227-19 (June 1987) or any equivalent agency regulation or contract clause. Use, duplication or disclosure of Software is subject to Agilent Technologies' standard commercial license terms, and non-DOD Departments and Agencies of the U.S. Government will receive no greater than Restricted Rights as defined in FAR 52.227-19(c)(1-2) (June 1987). U.S. Government users will receive no greater than Limited Rights as defined in FAR 52.227-14 (June 1987) or DFAR 252.227-7015 (b)(2) (November 1995), as applicable in any technical data.

Document Warranty

The material contained in this document is provided "as is," and is subject to being changed, without notice, in future editions. Further, to the maximum extent permitted by applicable law, Agilent disclaims all warranties, either express or implied, with regard to this manual and any information contained herein, including but not limited to the implied warranties of merchantability and fitness for a particular purpose. Agilent shall not be liable for errors or for incidental or consequential damages in connection with the furnishing, use, or performance of this document or of any information contained herein. Should Agilent and the user have a separate written agreement with warranty terms covering the material in this document that conflict with these terms, the warranty terms in the separate agreement shall control.

Technology Licenses

The hardware and/or software described in this document are furnished under a license and may be used or copied only in accordance with the terms of such license.

WARNING

A WARNING notice denotes a hazard. It calls attention to an operating procedure, practice, or the like that, if not correctly performed or adhered to, could result in personal injury or death. Do not proceed beyond a WARNING notice until the indicated conditions are fully understood and met.

CAUTION

A CAUTION notice denotes a hazard. It calls attention to an operating procedure, practice, or the like that, if not correctly performed or adhered to, could result in damage to the product or loss of important data. Do not proceed beyond a CAUTION notice until the indicated conditions are fully understood and met.

Trademark Acknowledgements

Windows and MS Windows are U.S. registered trademarks of Microsoft Corporation.